



Ecoer TDi Pro R-410A Unitary Service Manual

Contents

- 1. General Information----- 2
- 2. Ecoer TDi Pro Unitary System----- 4
 - 2.1 Refrigerant Circuit----- 4
 - 2.2 Function and Control----- 8
 - 2.3 Field Setting----- 21
- 3. Troubleshooting----- 31
 - 3.1 Problems without Codes ----- 31
 - 3.2 Error Codes list ----- 33
- 4. Parts List----- 62
- 5. Appendix----- 64
 - 5.1 Sensor Characteristics----- 64
 - 5.2 Wiring Diagram----- 68



All phases of this installation must comply with National, State and Local Codes.

IMPORTANT

These instructions do not cover all variations in systems or provide for every possible contingency to be met in connection with installing and servicing. Should further information be desired or should particular problems arise which are not covered sufficiently for the purchaser’s purposes, the matter should be referred to local distributor.



1 General Information

Outdoor Unit	E	O	D	A	19	H	-	4860	A	A	A
	1	2	3	4	5	6	7	8	9	10	
Brand E: Ecoer											
Product O: Top Discharge Condensing Unit											
Control Method D: Non-Communicating											
Power A: 208/230V-1Ph-60Hz											
SEER2 19: 19SEER2 Series											
Type H: Heat Pump C: Air Conditioner											
Capacity 2436: up to 3Ton 4860: up to 5Ton											
Series A, B, C etc. U: Ultra Heating											
Refrigerant A: R410A											
Revisions A, B, C etc.											

1 General Information

Indoor Unit	E	AH	A	T	N	-	36	B	A	A
	1	2	3	4	5	6	7	8	9	
Brand E: Ecoer										
Product AH: Air Handler FC: Fan Coil										
Power A: 208/230V-1Ph-60Hz										
Metering device T: TXV E: EEV										
Control Method N: 24V Non-Communicating C: Communicating										
Capacity 24=2Ton 36=3Ton 48=4Ton 60=5Ton										
Series A, B, C etc.										
Refrigerant A: R410A										
Revisions A, B, C etc.										

2 Ecoer TDi Pro Unitary System

2.1 Refrigerant Circuit

2.1.1 Functional Parts Layout of Condensing Units

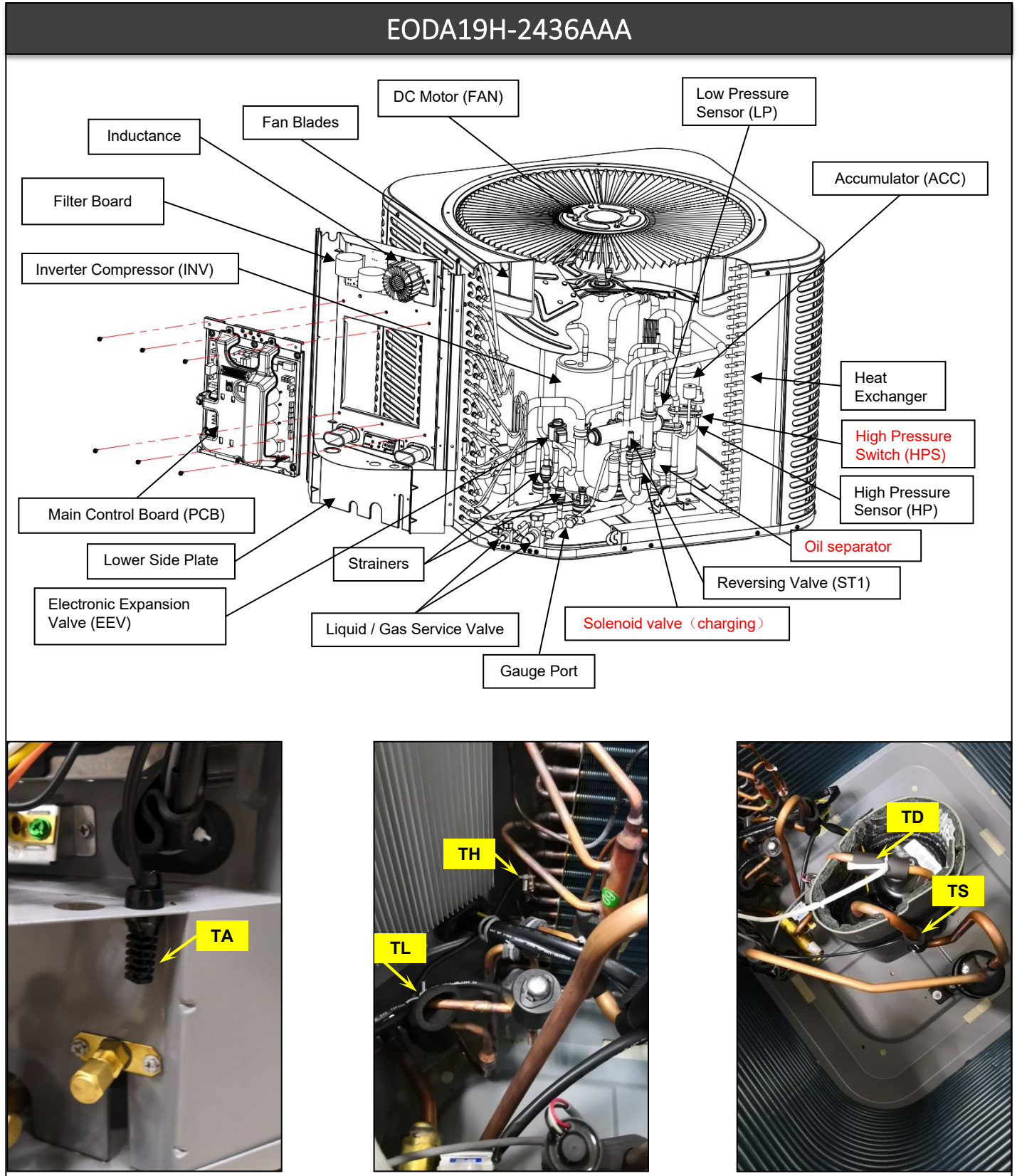

EODA19H-4860AAA

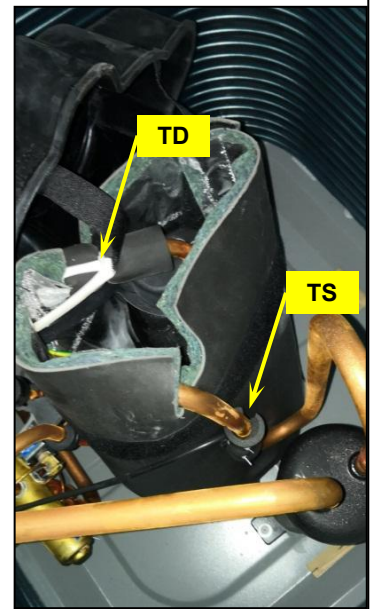
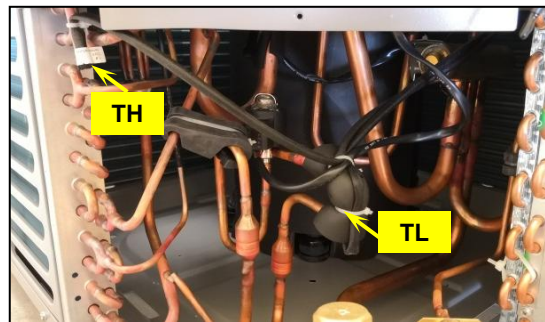
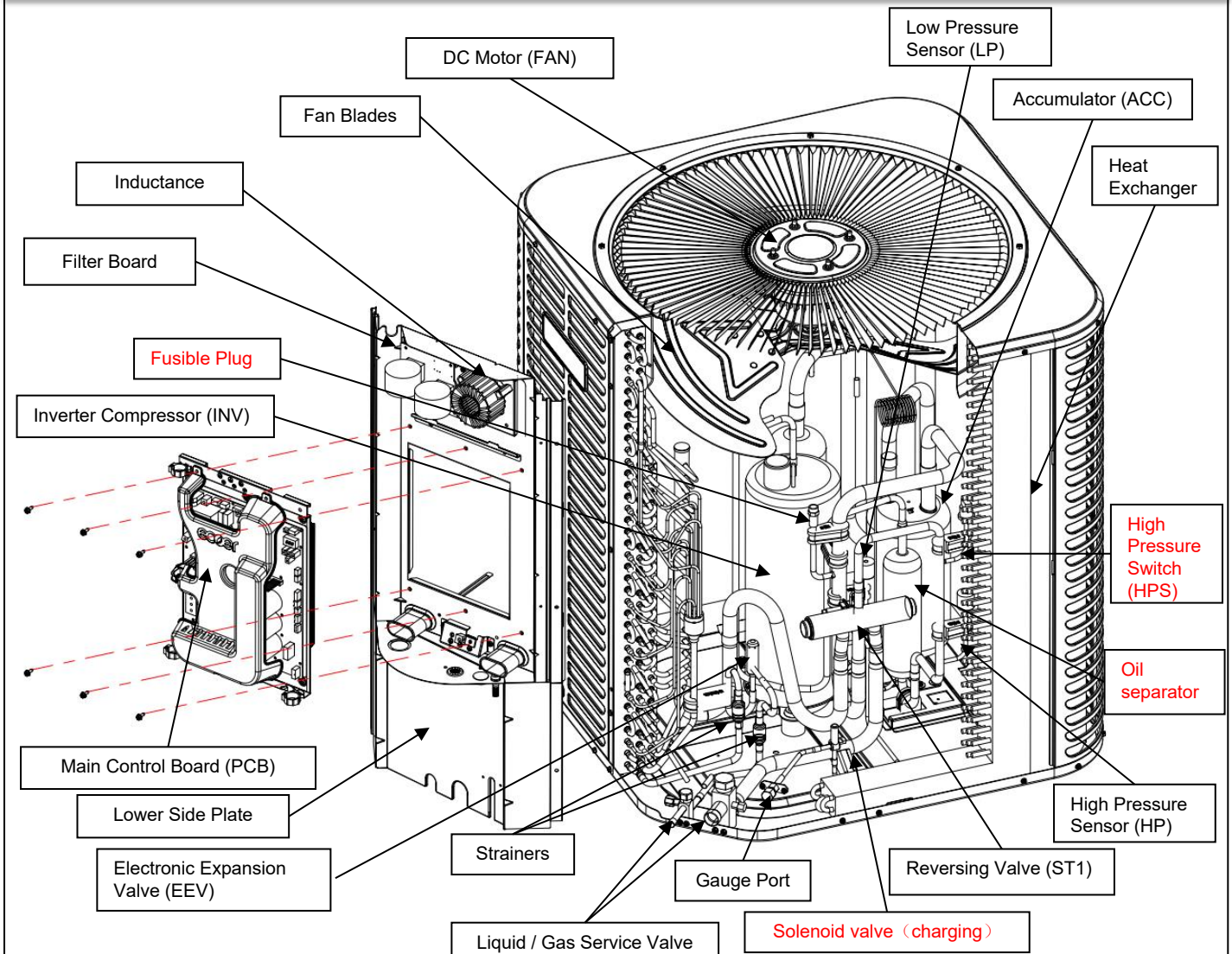

TIPS:
 Remove screws to take away the lower side plate to access TH / TL sensors.
 A slotted screwdriver may be required to open the plate from the condensing

2.1.2 Major Components Functions and Refrigerant Circuits Diagram

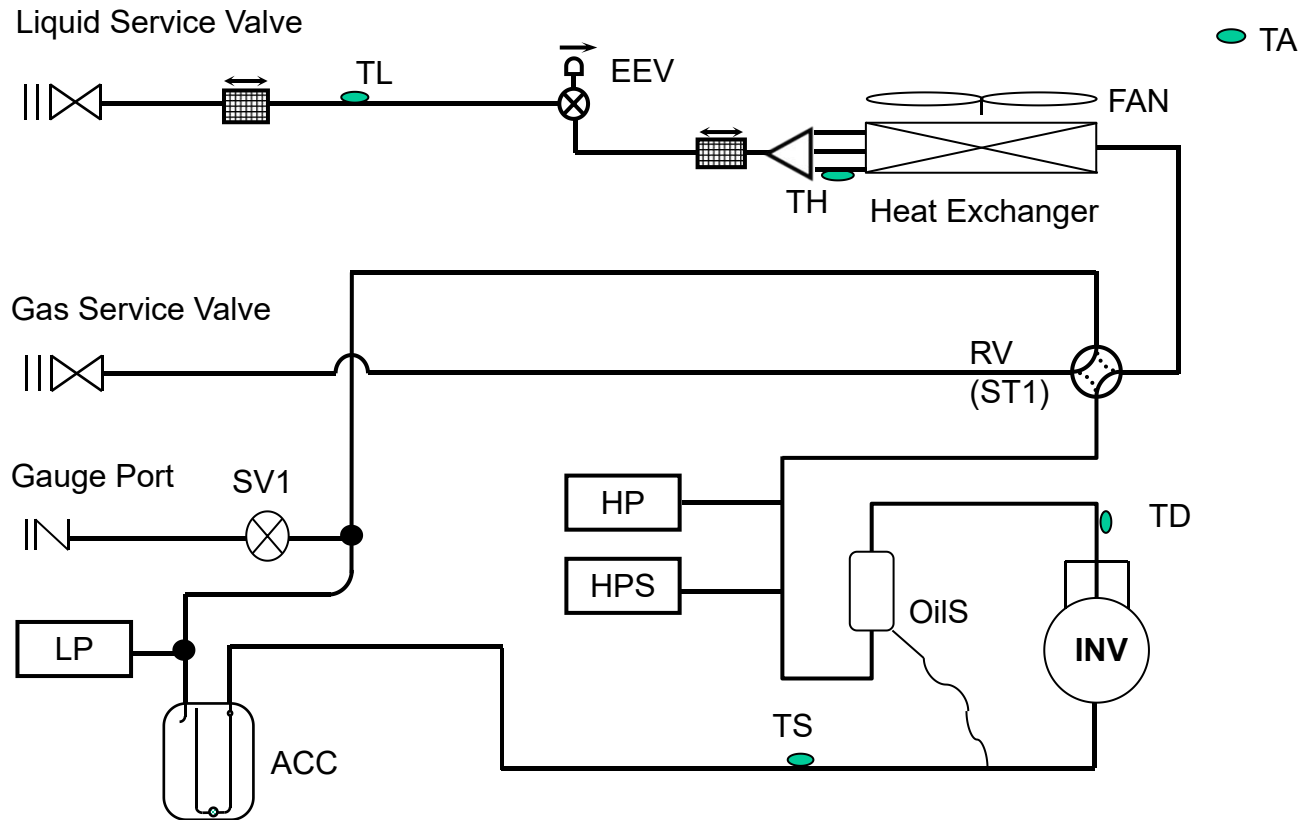

Name	Symbol	Function
Inverter compressor	INV	Adjusts refrigerant flow rate by changing the compressor speed (RPS) based on objective pressure.
Oil separator	Oils	The compressor oil is collected and returned to the compressor.
DC motor	FAN	Outputs heat exchanger capacity by adjusting the motor rotation speed based on operating pressure.
Electronic expansion valve	EEV	1) Fully open in cooling mode and defrost operation. 2) Control compressor discharge superheat in heating mode.
Reversing valve	RV (ST1)	Switches the operation mode between heating and cooling (including defrost control).
Solenoid valve 1	SV1	(Normally close) Control charging on and off when in charging mode.
Temperature sensor	TA	Uses to detect outdoor air temperature and control fan speed.
	TS	Uses to detect compressor suction temperature and calculate compressor suction superheat (SSH).
	TD	Uses to detect compressor discharge temperature and calculate compressor discharge superheat (DSH).
	TH	Uses to control defrosting during heating operation.
	TL	Uses to detect liquid line temperature and calculate sub-cooling (SC).
	TF	Uses to detect heat sink temperature of inverter module.
High pressure sensor	HP	Uses to detect high pressure.
Low pressure sensor	LP	Uses to detect low pressure.
Accumulator	ACC	Uses to store excess refrigerant.

2.1.3 Refrigerant Flow of Each Operation Mode

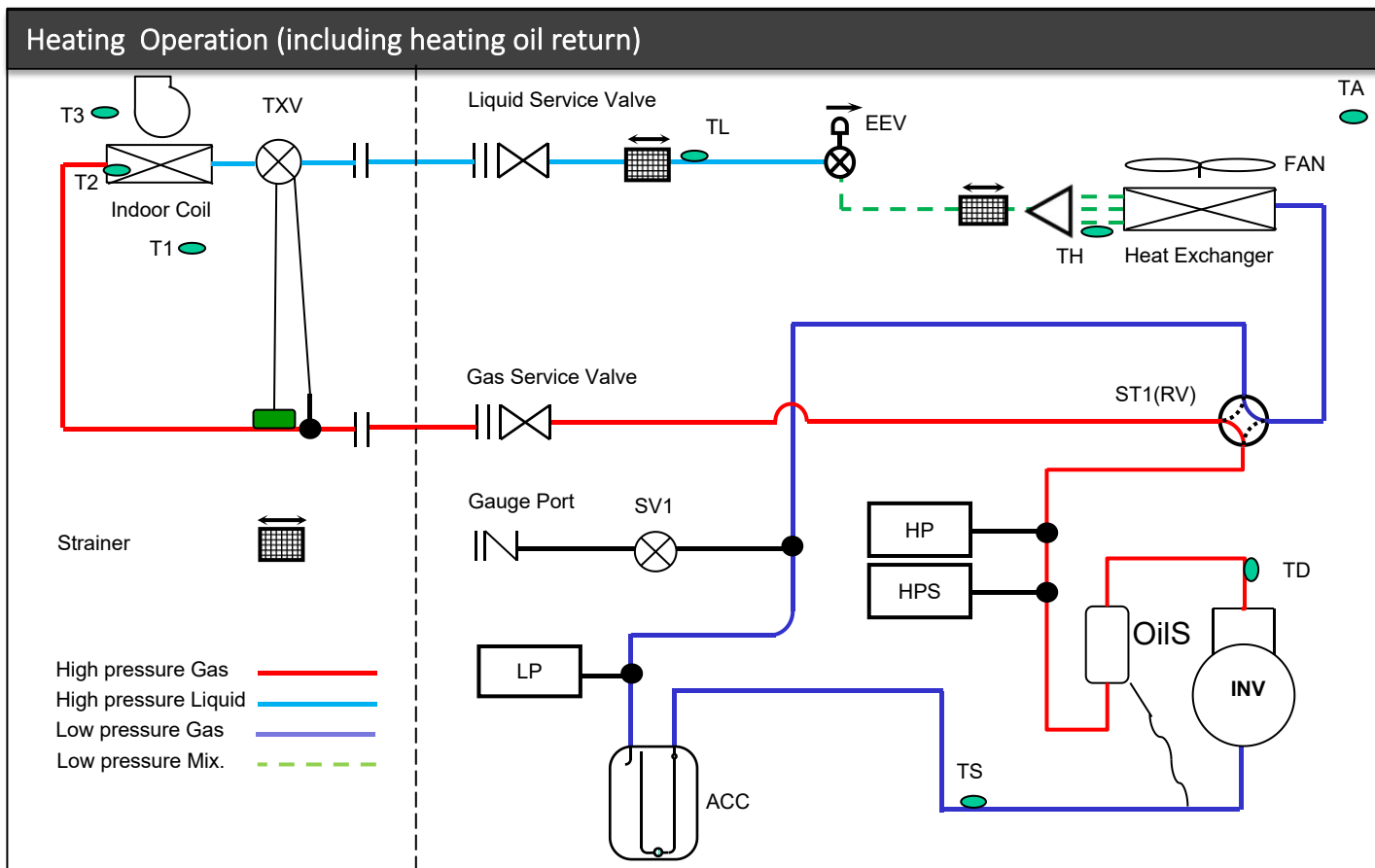
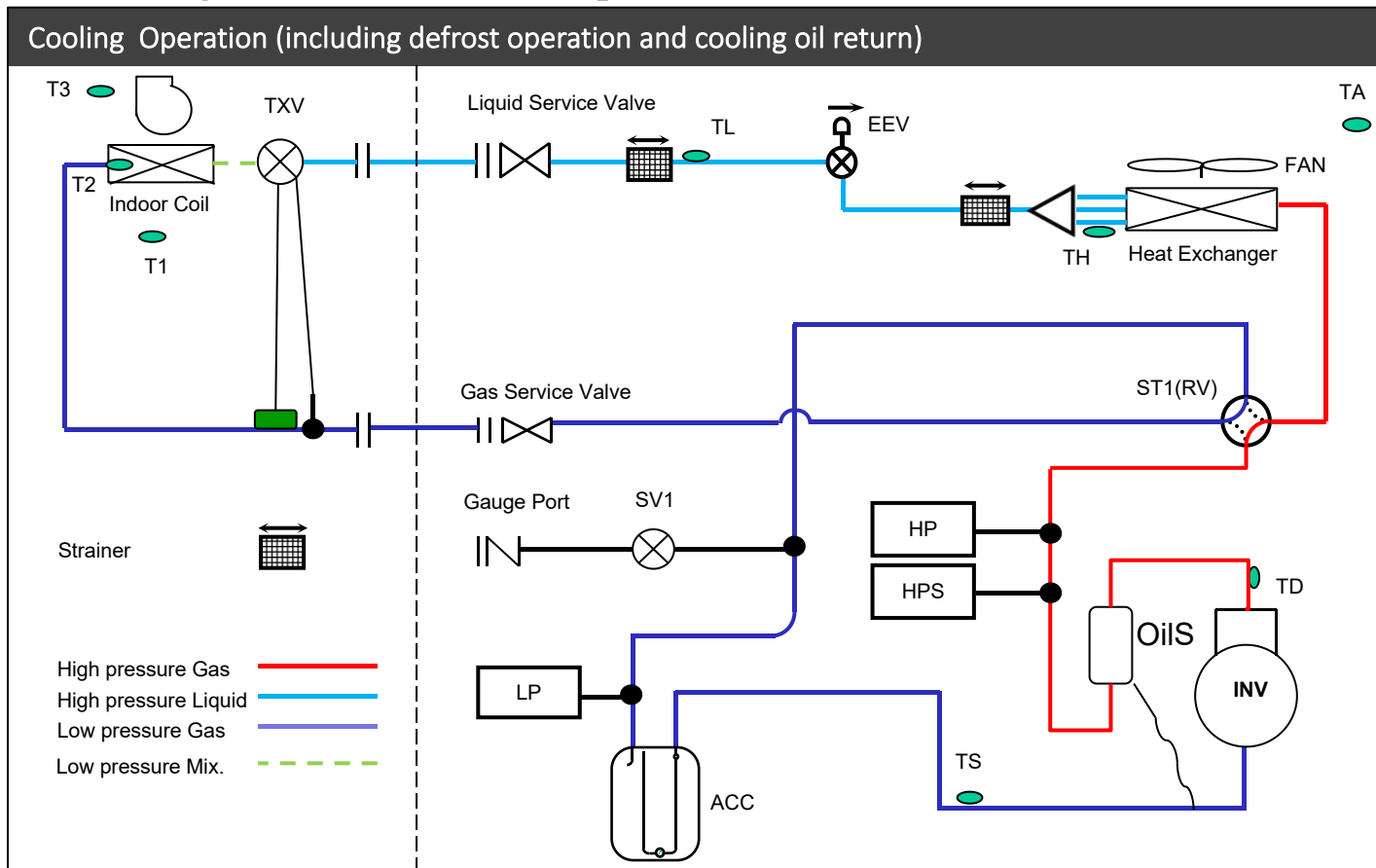

2.2 Function and Control

2.2.1 Operation Mode

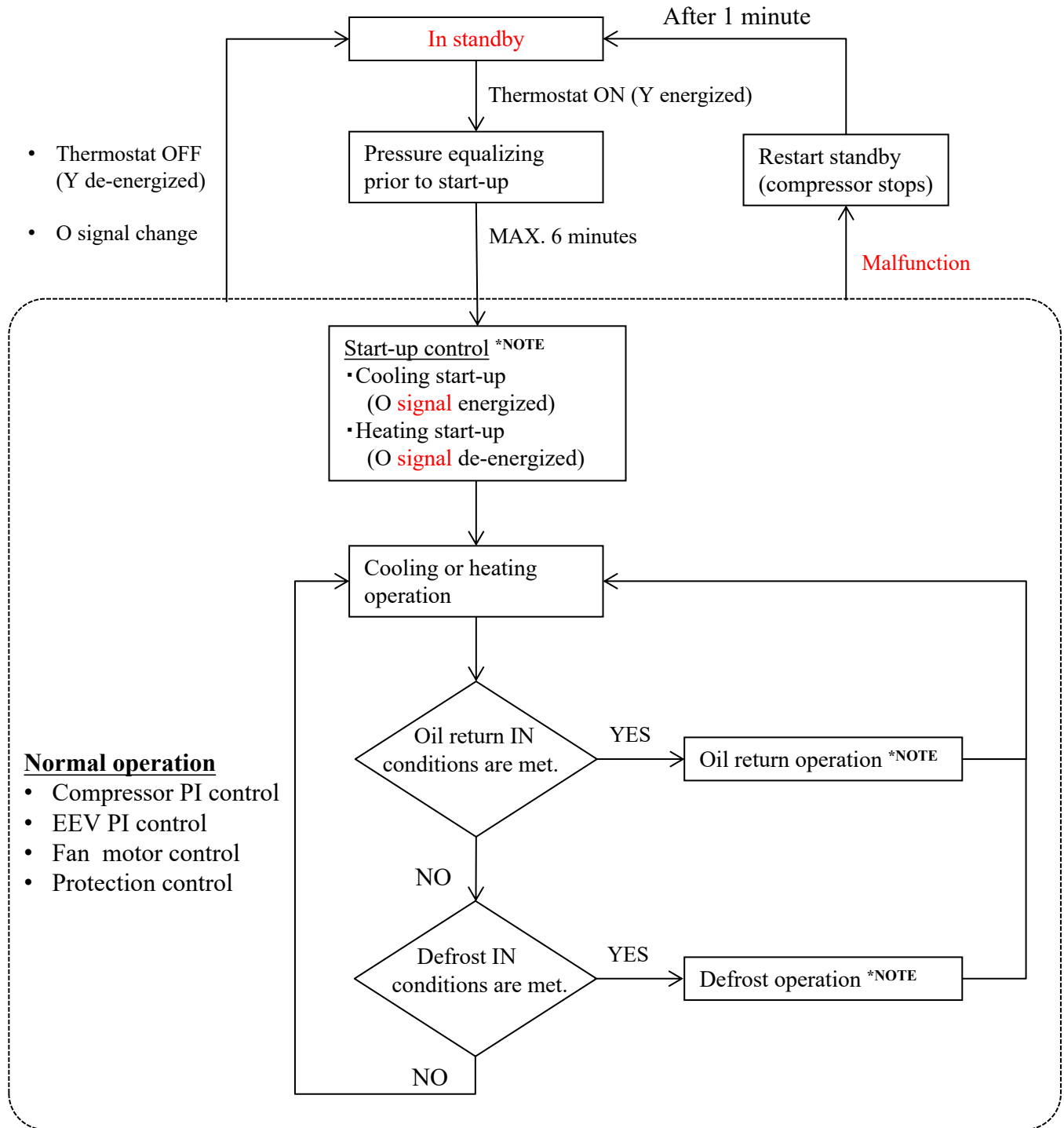

NOTES: The operation may be enforced to complete under some conditions.

2.2.2 Basic control

2.2.2.1 Normal control

Input Signal	Actuator	Cooling control (including cooling oil return)	Heating control (including heating oil return)
Y	Compressor (INV)	Apply PI control to maintain Tes*1	Apply PI control to maintain Tcs*1
Y / O*2	Outdoor fan (FAN)	Cooling fan control	Heating fan control
O*2	Reversing valve (ST1)	De-energized(208/230VAC)	Energized (208/230VAC)
Y / O*2	Electronic expansion valve (EEV)	480pls	PI control to maintain discharge superheat (DSH)

Remarks:

- Tes: Target Te value (Varies depending on the load of space, mode choice, silent setting, etc.)
 Te: Low pressure equivalent saturation temperature
 Tcs: Target Tc value (Varies depending on the load of space, mode choice, silent setting, etc.)
 Tc: High pressure equivalent saturation temperature
- SW1_3=OFF (factory), condensing unit uses Y/C/O (**O for cooling**) signal to operate heat pump.
 SW1_3=ON has been set, condensing unit uses Y/C signal to run cooling only.

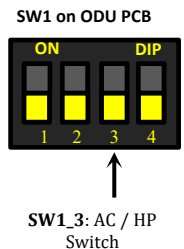

2.2.2.2 Defrost control

This system carries out demand defrost control if any one of the following conditions satisfy.

- The calculated temperature difference between ambient temperature (TA) and defrost temperature (TH) is called Delta T. After Delta T is achieved and continues for 5 minutes.

 - TA is between 41°F and 59 °F: TH ≤ 30°F, Delta T = 18°F
 - TA is between 19°F and 41°F: TH ≤ 30°F, Delta T = 12~18°F
 - TA is less than 19°F: TH < 9°F, accumulative compressor run time ≥ 80 minutes

TH back-up running: TA < 59°F and LP ≤ 90psi, accumulative compressor run time ≥ 60 minutes
- After “Minimum Run Time” (MRT) is achieved.

 - MRT is 3.5 hours if TA is less than 23°F
 - MRT is 2 hours if TA is between 23°F and 43°F
- The high pressure drops below 245psi for 20 minutes if TA is between 14°F and 28°F.

Defrost Exit:

Defrost will be terminated once defrost temperature sensor (TH) reaches 64°F for one (1) minute or the defrost time has exceeded eight (8) minutes. Defrost mode setting (n04) offers termination options for different geographical conditions.

- Defrost in heavy snow area will extend defrost for one (1) minute, but reduce the heating time to execute more defrost cycles.
- Defrost in light snow area will reduce defrost for 30 seconds.

2.2.2.3 Manual Defrost

Manual defrosting mode can be used when verifying defrosting or forcing defrosting.

Note: After 5-10 minutes of continuous heating operation, the unit can respond to manual defrosting in time; otherwise, the unit will enter after meeting the requirements.

Enter in either way:

- a. n08 setting;
- b. Hold on BS1+BS2 for more than 5 seconds, release and wait about 1 minute.

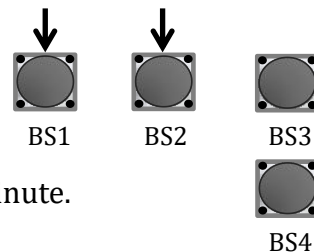

Exit in either way:

Defrost exit automatically/Heating demand off/Power off

2.2.2.4 AUTO charge mode in cooling or **Rated running mode**

a. Actuator and procedure

Actuator	AUTO charge mode OR Rated running in cooling	Rated running in heating
Compressor (INV)	Rated compressor speed in cooling	Rated compressor speed in heating
Outdoor fan (FAN)	Cooling fan control	Heating fan control
Reversing valve (ST1)	De-energized(208/230Vac)	Energized (208/230Vac)
Electronic expansion valve (EEV)	480pls	PI control to maintain DSH

Step by Step procedure (A: Charging mode/B: Rated running):

1. Setting the operating mode from thermostat.

*Note: A low(cooling)/high(heating) target temperature is recommended for continuous operation of the unit.

2. Run for about 15 minutes.

3. Check the SSH (only for charge mode in cooling):

If the suction superheat is beyond 7-20°F, please use a wrench to **adjust** the TXV opening.

4. In the operation, setting Rated running model from OD unit.

Please Hold and press BS4 button for 5 seconds until you see blinking "7" .

*Note: Once Rated running is activated. The coefficient number (or "--") and "7" will be displayed on LED alternately in about 1 minute.

5. Run for another 10 minutes.

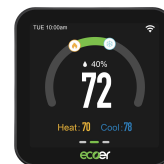

**Rough Target SSH
in cooling**



Note: SSH are available from Spot Check(03-) by press BS3 or Ecoer Pro APP.

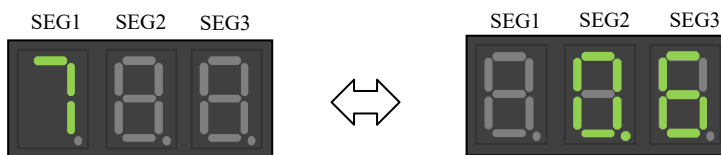
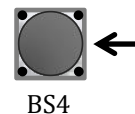

6. A: Check the refrigerant coefficient:

Check refrigerant coefficient number from LED display or ESS Pro App, **pls see nest page for the suggestion of charging.**

If adjust the charging, please repeat 5.1 after 5 minutes.

6. B: Check operating status:

Check the operation status as field required

Use either way below to end :

Press BS4/shut off from thermostat/Power off/running for 120 minutes.

b. Charge confirm in Auto charge mode in cooling

**It is the only recommended method of charging above 55°F outdoor ambient temperatures.

**It is important to return in the spring or summer to accurately charge the system in the cooling mode when outdoor ambient temperature is above 55°F.

Run the system for 15~20 minutes and check **refrigerant coefficient** number (here short for "X", $0 < X < 1$) from the LED display. If $X > 0.6$, remove refrigerant; or $X < 0.4$, add more refrigerant. Then wait for 5 minutes to allow system pressure balanced. Check the new coefficient number to make sure you get 0.5 -- 0.6. Basically, 0.4 to 0.6 is acceptable if $7^{\circ}\text{F} \leq \text{SSH} \leq 20^{\circ}\text{F}$.

When the LED displays "--" for more than 20 minutes, stop charging and adjust the TXV opening to ensure required compressor suction superheat (Refer to the TIPS "How to adjust indoor TXV opening").

Refrigerant coefficient

The refrigerant coefficient is used to evaluate the refrigerant level in the ecoer system.

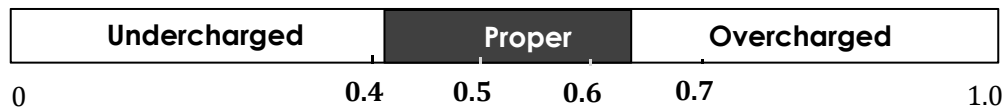
**Use either way below to end AUTO charge mode**

Press **BS4 once**/ After 2 hours running (Automatically EXIT)/ Turn off the system at thermostat

NOTES:

- This AUTO charge mode is suitable for ambient temperature between 50°F and 115°F. But for the best results, indoor temperature should be kept between 70°F and 80°F. For outdoor ambient temperature is below 50°F, use weigh-in charge method only.



Fig 13-2 Temperature limit for AUTO charge mode

2. Start-up control is enforced to complete prior to activate the AUTO charge mode. It may take 4 to 10 minutes to exit start-up control procedure and fix the compressor speed (RPS).
3. The service valve is usually closed except in charge mode. If you need to know the suction pressure, you can log in to ESS Pro, or read the parameter of "07" from Spot check.

c. Fully automatic refrigerant charging(**FARC**)

Refrigerant charging if the unit is undercharged:

1. Connect the refrigerant tank to the service gauge port of the unit and open all the service valves.
2. Power on the system and set the thermostat to the cooling mode.
3. Press and hold the BS4 button for 5 seconds until the display starts blinking "7".
4. Wait for at least 1 hour, and the system will automatically charge the refrigerant to the appropriate level.
5. Remove the refrigerant tank.

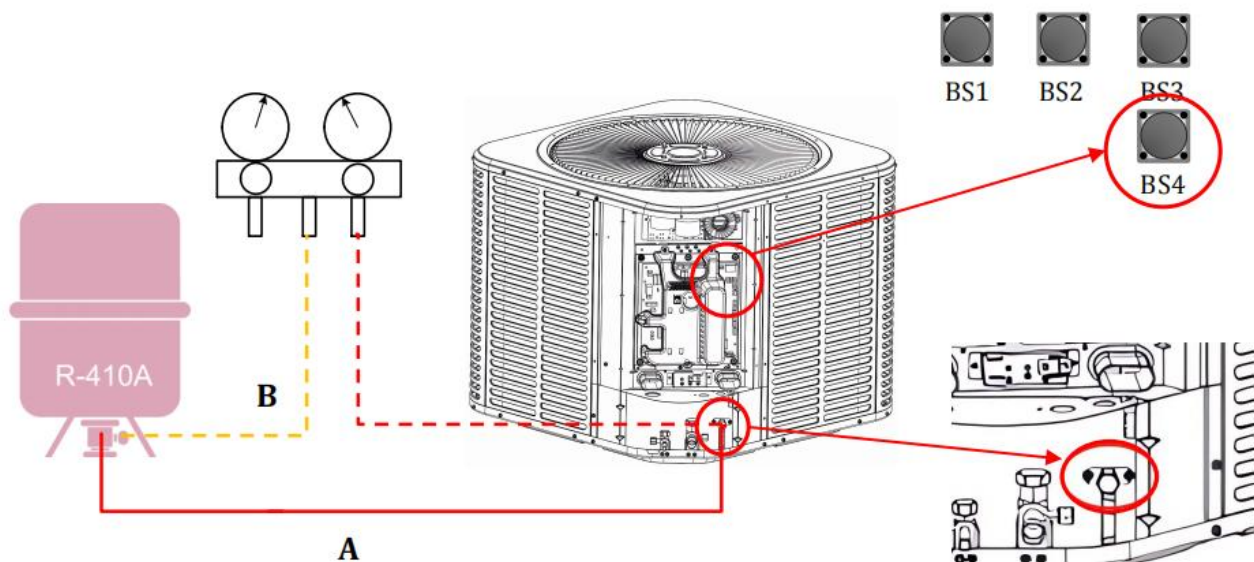

NOTES:

1. Prior to opening the service valves, ensure to purge all the hoses.
2. Make sure to place the refrigerant tank upside down before connecting it.
3. Only one hose (Connection A) is needed for the refrigerant charge. If you want traditional connection, you can also use a pressure gauge (Connection B).

2.2.2.5 Pump down function

b. Pump down in cooling only

Actuator	Pump down in cooling
Compressor (INV)	Rated compress speed to Low compressor speed
Outdoor fan (FAN)	Cooling fan control
Reversing valve (ST1)	De-energized
Electronic expansion valve (EEV)	480pls

Pump down Step by Step:

1. Setting in cooling mode from thermostat.

*Note: A low target temperature is recommended for continuous operation of the unit.

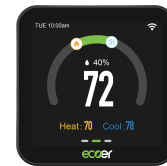

2. Run for about 10 minutes.

3. In cooling running, Setting Pump down mode from OD unit.

Please Hold and press BS4 button for 5 seconds until you see blinking '7', press BS2 button in one minute to get '8'.

*Note: Once pump down is activated. "8" or "8" alternating with LP (PSIG) will be displayed on the LED.

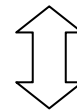
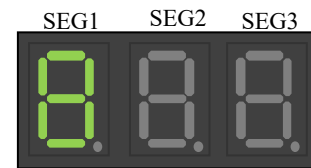
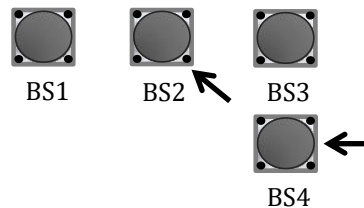

4. Confirm the alternate display of "8" and LP(PSIG), close the liquid service valve, and then close service valve quickly when the suction pressure drops to 40 PSIG.

Note: The pressure protection is valid if LP < 24.5 PSIG.

Note: It is recommended to close the two service valves to half first to deal with LP protection shutdown more quickly.

5. Power off.

Use either way below to end :

Press BS4/shut off from thermostat/Power off/running for 120 minutes.

2.2.2.6 Compressor control

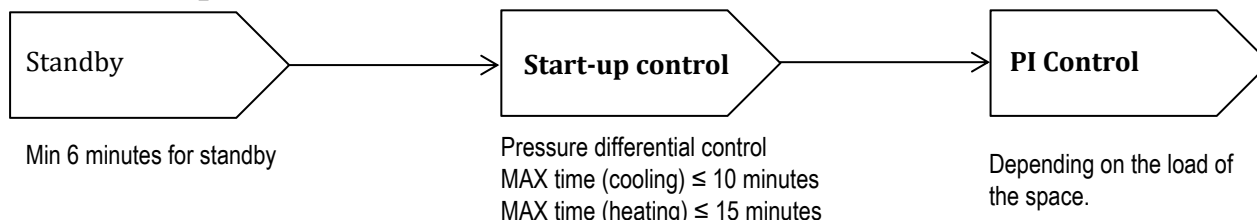

[Compressor RPS VS STEP]

STEP	RPS	STEP	RPS	STEP	RPS	STEP	RPS	STEP	RPS
1	-	10	30	19	48	28	66	37	84
2	-	11	32	20	50	29	68	38	86
3	16	12	34	21	52	30	70	39	88
4	18	13	36	22	54	31	72	40	90
5	20	14	38	23	56	32	74	41	92
6	22	15	40	24	58	33	76	42	94
7	24	16	42	25	60	34	78	43	96
8	26	17	44	26	62	35	80	44	98
9	28	18	46	27	64	36	82	45	100

Outdoor Capacity	2Ton	3Ton	4Ton	5Ton
Cooling Max RPS	70	86	66	76
Heating Max RPS (Ta≥45°F)	66	84	66	76
Heating Max RPS (45°F>Ta≥23°F)	80	94	80	86
Heating Max RPS (Ta<23°F)	90	108	86	92

2.2.2.7 Fan control



[Fan RPM VS STEP]

Mode	STEP/RPM								
	Tons	0	1	2	3	4	5	6	7
2	0	250	350	430	530	630	660	780	880
3	0	250	350	480	580	660	730	830	930
4	0	250	350	480	580	700	780	880	980
5	0	250	350	550	630	780	830	930	1030

2.2.2.8 Electronic expansion valve (EEV) control

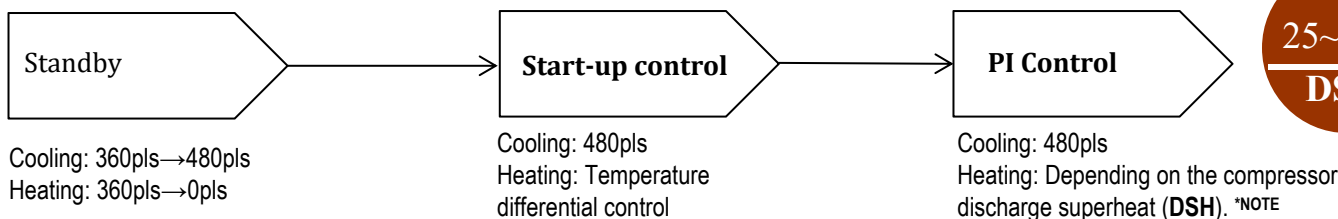

Cooling: 360pls→480pls
Heating: 360pls→0pls

Cooling: 480pls
Heating: Temperature differential control

Cooling: 480pls
Heating: Depending on the compressor discharge superheat (DSH). *NOTE

25~60°F
DSH

NOTE: Heating DSH should be between 25 °F and 60 °F with proper refrigerant level.

2.2.2.9 Silent mode

In order to decrease the noises produced by condensing unit, the crucial noise resources should be limited. Once the silent mode has been activated by n05, n06 and n07 (refer to field setting), both the highest compressor frequency (RPS) and fan speed (RPM) are limited.

Maximum compressor frequency

Cooling Max Compressor RPS			
Condenser Capacity	Standard Mode	Silent Mode (Level 1)	Super Silent Mode (Level 2)
2Ton	70	66	56
3Ton	80	76	70
4Ton	66	66	56
5Ton	76	68	58

Heating Max Compressor RPS			
Condenser Capacity	Standard Mode	Silent Mode (Level 1)	Super Silent Mode (Level 2)
2Ton	90	70	60
3Ton	108	78	72
4Ton	86	62	52
5Ton	92	70	60

Maximum fan speed

Max Fan Speed (RPM)			
Condenser Capacity	Standard Mode	Silent Mode (Level 1)	Super Silent Mode (Level 2)
2Ton	880	640	530
3Ton	930	730	580
4Ton	980	780	580
5Ton	1030	830	630

2.2.2.10 Snow Sensor Control

To prevent the fan of condensing unit from covering up by heavy ice. Ecoer equips with the snow sensor control function if the ambient temperature is no higher than 41F.

When the snow sensor control works, ODM rotate at the 3th step for 2min then shut down.

ODU	OD Fan Tap	Heavy Snow	Standard	Light Snow
2/3T	STEP3	30 min	90 min	120 min
4/5T	STEP3			

SW1 Dip switch		Description	
NO.	Setting item	Status	Content
1	Snow Sensor Control *	ON	Disable
		OFF (factory)	Enable

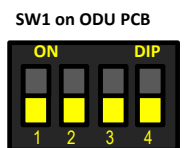

SW1_1:
Snow Sensor Control

2.2.3. Protection controls

2.2.3.1 High pressure protection control

High pressure (HP) protection control is used to prevent extremely high pressures in the system and protect the compressor.

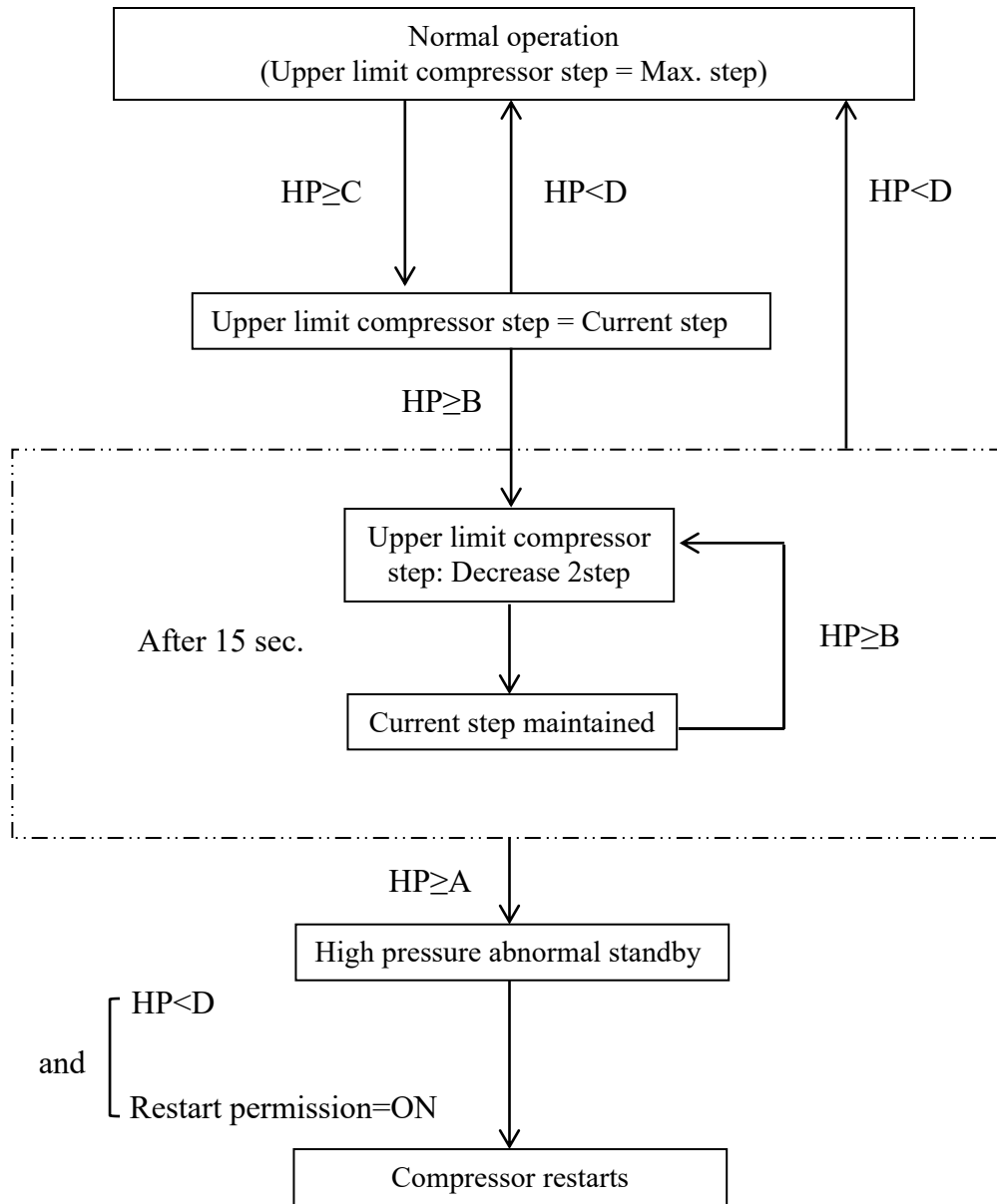

Symbol	EODA19H-2436A/4860A	
	Cooling	Heating
A	566psig [3.90MPa]	529psig [3.65MPa]
B	529psig [3.65MPa]	506psig [3.49MPa]
C	506psig [3.49MPa]	483psig [3.33MPa]
D	495psig [3.41MPa]	461psig [3.18MPa]

2.2.3.2 Low pressure protection control in cooling mode

Low pressure (LP) protection control in cooling is used to protect compressor against the transient decrease of low pressure.

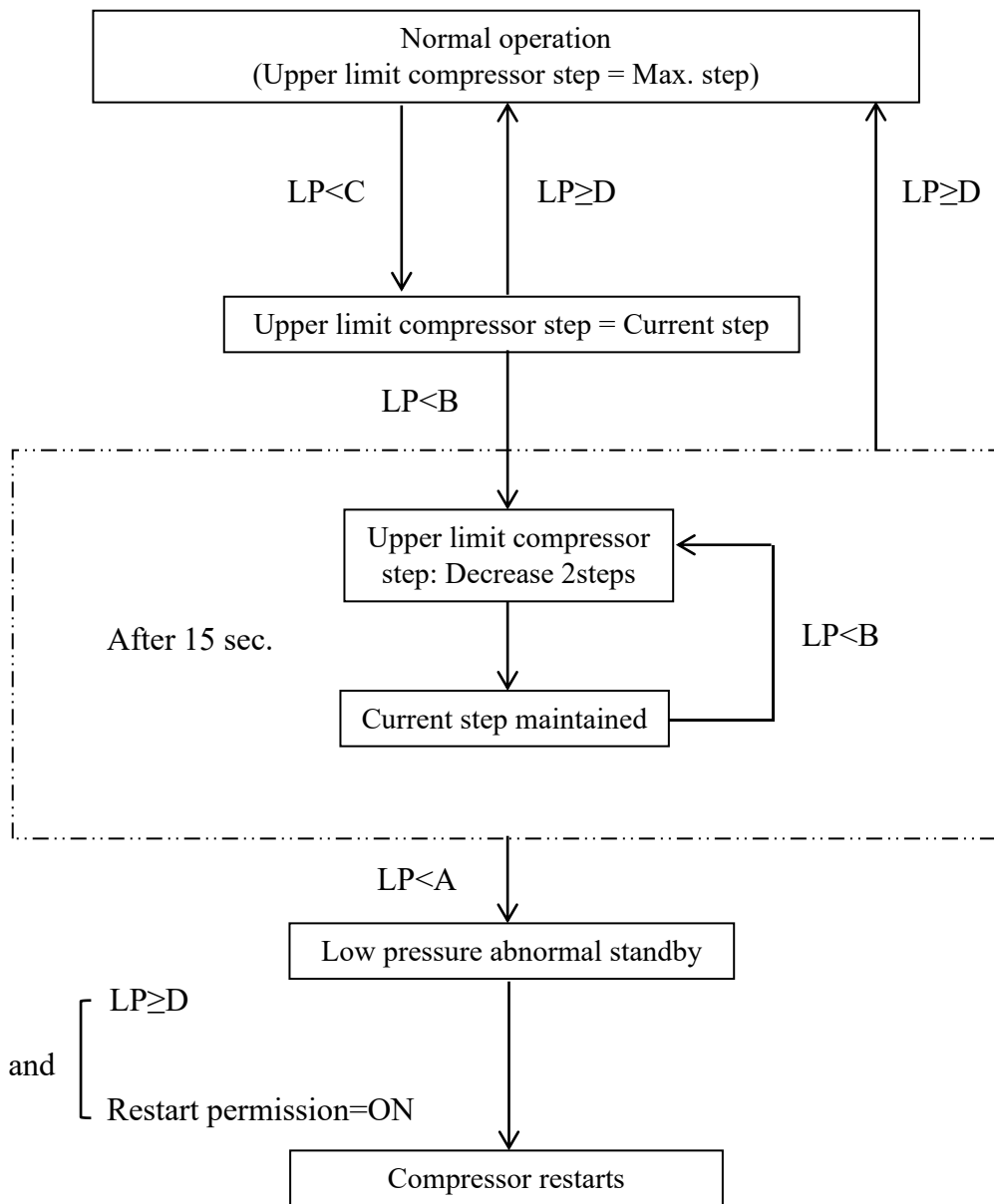

Symbol	EODA19H-2436A/4860A	
	Cooling	Heating
A	24.5psig [0.17MPa]	0psig [0MPa]
B	43.5psig [0.30MPa]	20.3psig [0.14MPa]
C	61.0psig [0.42MPa]	24.5psig [0.17MPa]
D	72.5psig [0.50MPa]	27.6psig [0.19MPa]

2.2.3.3 Discharge temperature protection control

This discharge temperature (TD) protection control is used to protect the compressor internal temperature against a malfunction or transient increase of discharge pipe temperature.

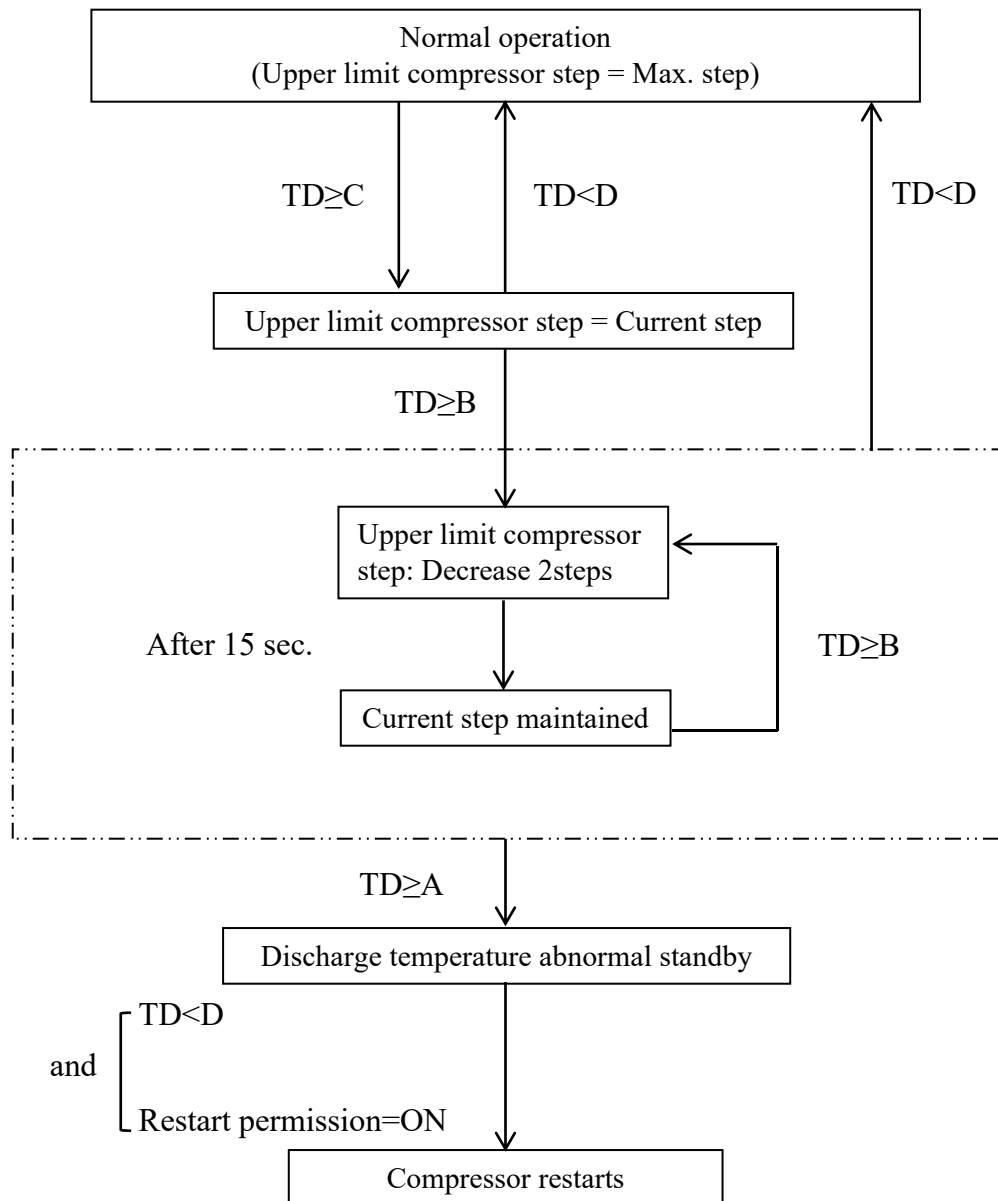

Symbol	EODA19H-2436A/4860A	
	Cooling	Heating
A	230°F (110° C)	212°F (100° C)
B	212°F (100° C)	194°F (90° C)
C	203°F (95° C)	185°F (85° C)
D	194°F (90° C)	176°F (80° C)

2.2.3.4 INV Module temperature protection control

Inverter module temperature (TF) protection control is performed to prevent tripping due to an abnormal increase in temperature.

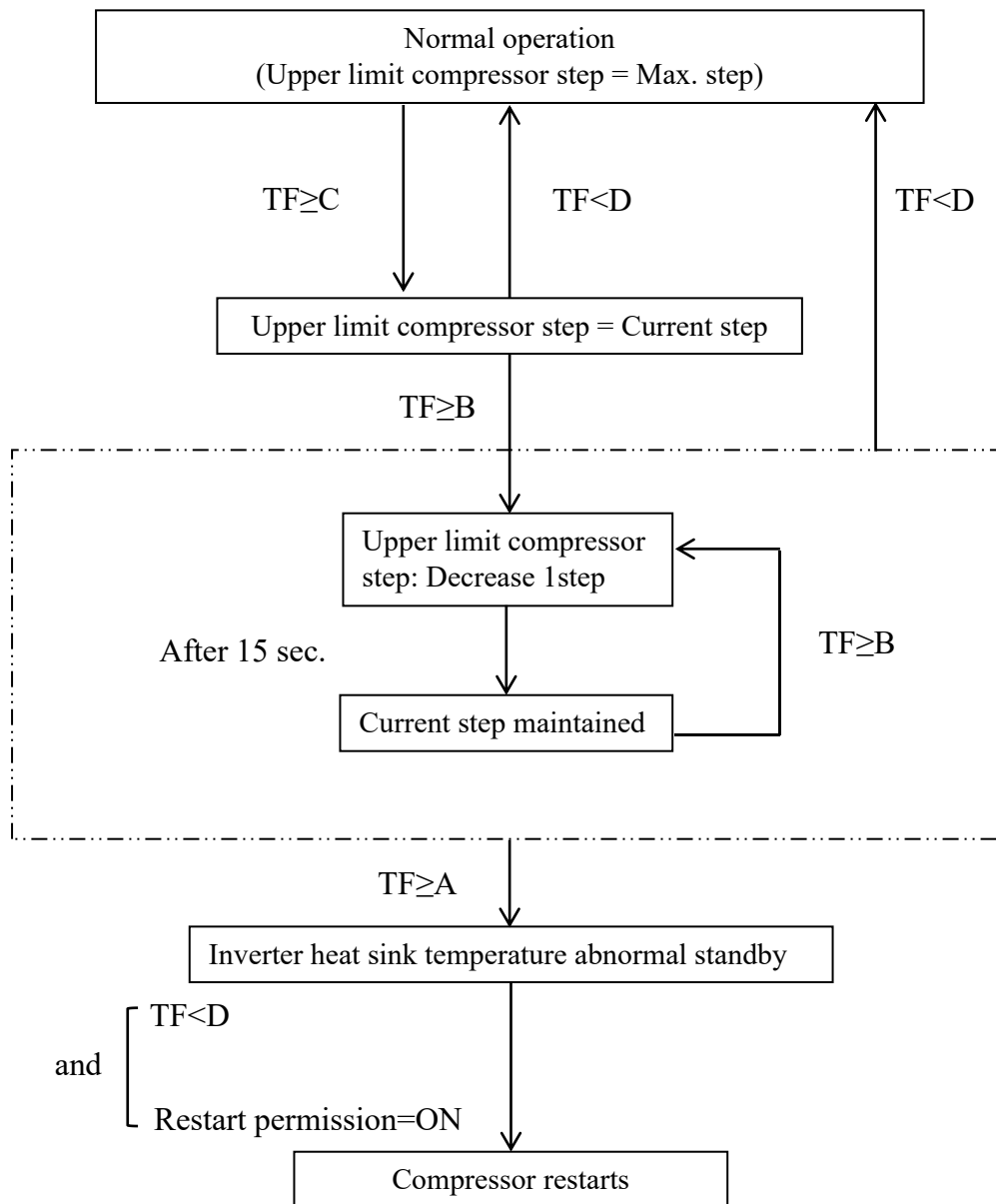

Symbol	EODA19H-2436A		EODA19H-4860A	
	Cooling	Heating	Cooling	Heating
A	185°F (85° C)	185°F (85° C)	185°F (85° C)	185°F (85° C)
B	176°F (80° C)	167°F (75° C)	176°F (80° C)	167°F (75° C)
C	171°F (77° C)	160°F (71° C)	171°F (77° C)	160°F (71° C)
D	167°F (75° C)	154°F (68° C)	167°F (75° C)	154°F (68° C)

2.2.3.5 Compressor over-current protection control

This control is performed to prevent tripping due to an abnormal transient compressor current (IA).

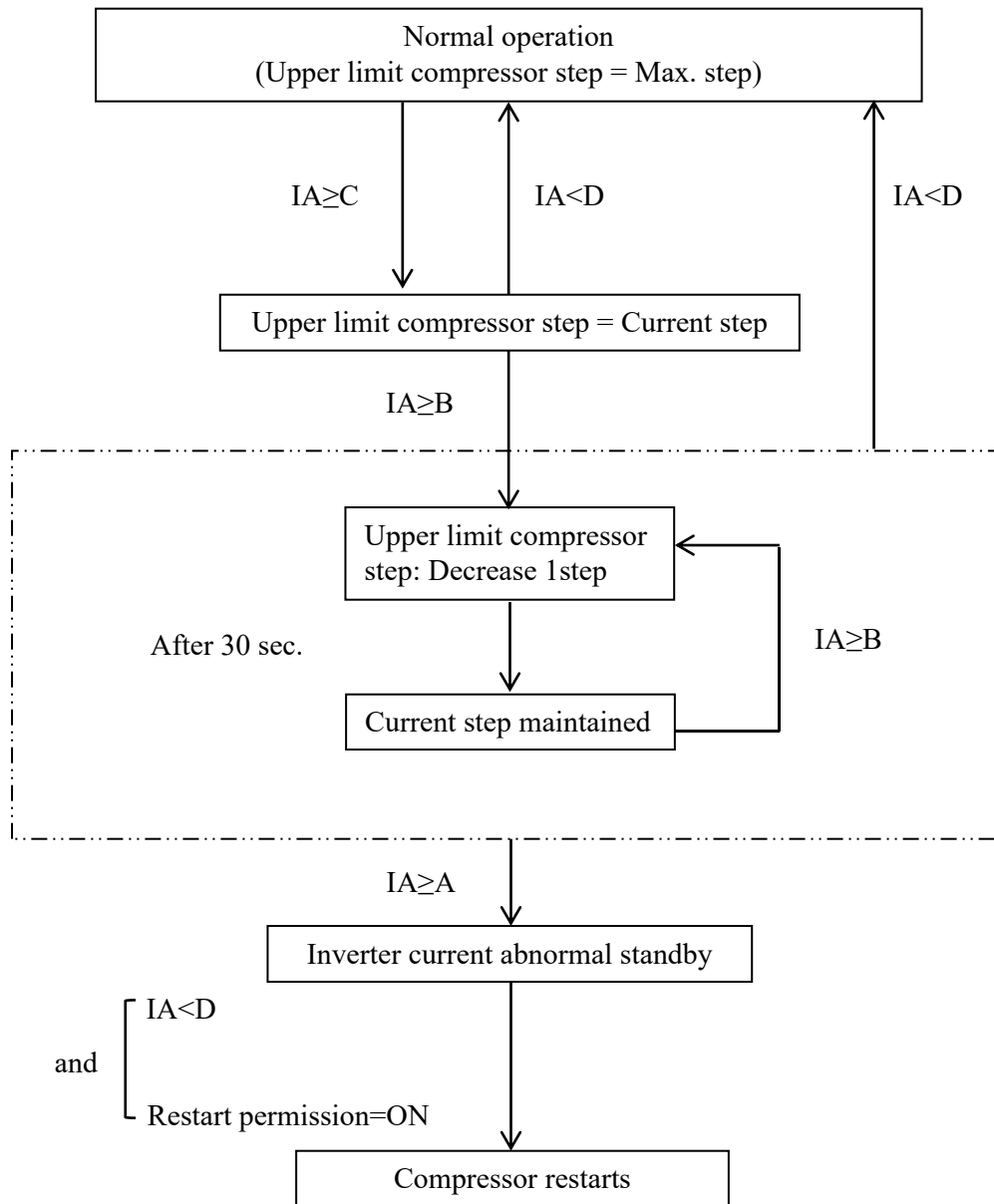

Symbol	EODA19H-2436A		EODA19H-4860A	
	Cooling	Heating	Cooling	Heating
A	14A	14A	20A	20A
B	9.5A	10.0A	13.0A	13.0A
C	9.1A	9.6A	12.6A	12.6A
D	8.6A	9.2A	12.0A	12.0A

2.3 Field Setting

2.3.1 Default display

LED on main control board can display the operating status of outdoor unit (ODU).

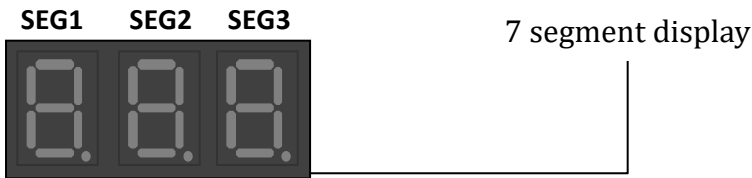

SEG1: Normally blank, but it displays codes “0 to 9” accordingly if there is damaged sensor and command response.

SEG1 Code	Description	Time
0	Software is updating through IoT device	About 5 min.
1	High pressure sensor (HP) fault back-up running	7 Days
2	Low pressure sensor (LP) fault back-up running	7 Days
3	Compressor discharge temperature sensor (TD) fault back-up running	7 Days
4	IPM module temperature sensor (TF) fault back-up running	7 Days
5	Ambient temperature sensor (TA) fault back-up running	120 Days
6	Defrost sensor (TH) fault back-up running	90 Days
7	Compressor suction temperature sensor (TS) fault back-up running	120 Days
8	Liquid line temperature sensor (TL) fault back-up running	120 Days
9	IoT command response	-

SEG2: Normally blank, but it will display code accordingly as below if outdoor unit is running under limited condition.

SEG2 Code	Description
0	Running under high pressure (HP) limit
1	Running under low pressure (LP) limit
2	Running under discharge temperature (TD) limit
3	Running under IPM module temperature (TF) limit
4	Running under compressor current limit

SEG3: It displays outdoor unit’s operation mode.

SEG3 Code	Description
0	Stop (Y signal de-energized)
1	Ready to start-up (Y signal energized) *Note
2	Cooling
3	Heating
4	Oil return
5	Defrost
6	Manual defrost
7	AUTO charge mode in cooling
8	Pump down

Note: Compressor waits three to eight minutes to restart.

Modes list (SEG3 Display)

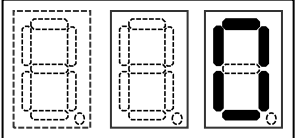
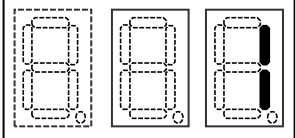
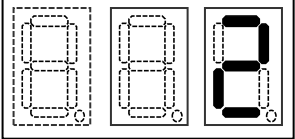
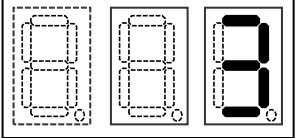
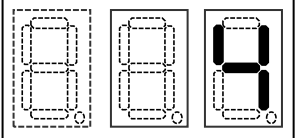
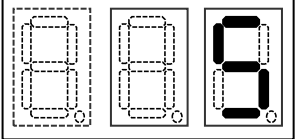
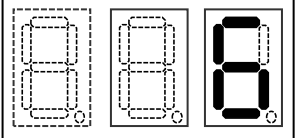
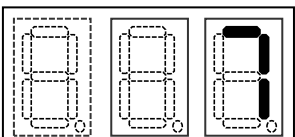
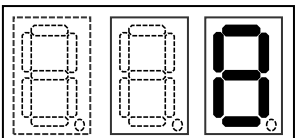
<p>Stop or standby (Y signal de-energized)</p>	<p>SEG1 SEG2 SEG3</p> 
<p>Ready to start-up (Y signal energized) (6 to 8 minutes for pressure equalization to restart)</p>	<p>SEG1 SEG2 SEG3</p> 
<p>Cooling</p>	<p>SEG1 SEG2 SEG3</p> 
<p>Heating</p>	<p>SEG1 SEG2 SEG3</p> 
<p>Oil return</p>	<p>SEG1 SEG2 SEG3</p> 
<p>Defrost</p>	<p>SEG1 SEG2 SEG3</p> 
<p>Manual defrost</p>	<p>SEG1 SEG2 SEG3</p> 
<p>AUTO charge mode in cooling</p>	<p>SEG1 SEG2 SEG3</p> 
<p>Pump down (only cooling)</p>	<p>SEG1 SEG2 SEG3</p> 

2.3.2 Setting by dip switches

Condensing functions can be applied by dipping switch and pressing buttons.

SW1 dip switch		Description	
NO.	Setting item	Status	Content
1	Snow Sensor Control ^{*a}	ON	Disable
		OFF (factory)	Enable
2	Capacity selection	ON	2 or 4 Ton
		OFF (factory)	3 or 5 Ton
3	AC only/Heat pump selection	ON	AC only
		OFF (factory)	Heat pump
4	Command ^{*b} response for IoT	ON	Disable
		OFF (factory)	Enable

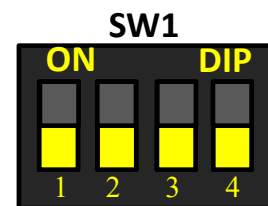

Use minor straight screwdriver to dip switch.
Must power off the unit for at least 2 minutes to activate the change.

^{*} Remote field setting, troubleshooting, software updates and so on.

2.3.3 Setting by pressing buttons

Query and setting operations can be done by pressing buttons on main control board.

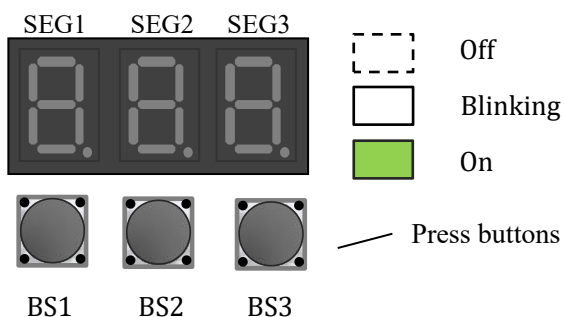

BS1: Menu or back button

BS2: UP button

BS3: Spot check and confirm button

Remarks: Press or tip any directions are valid.

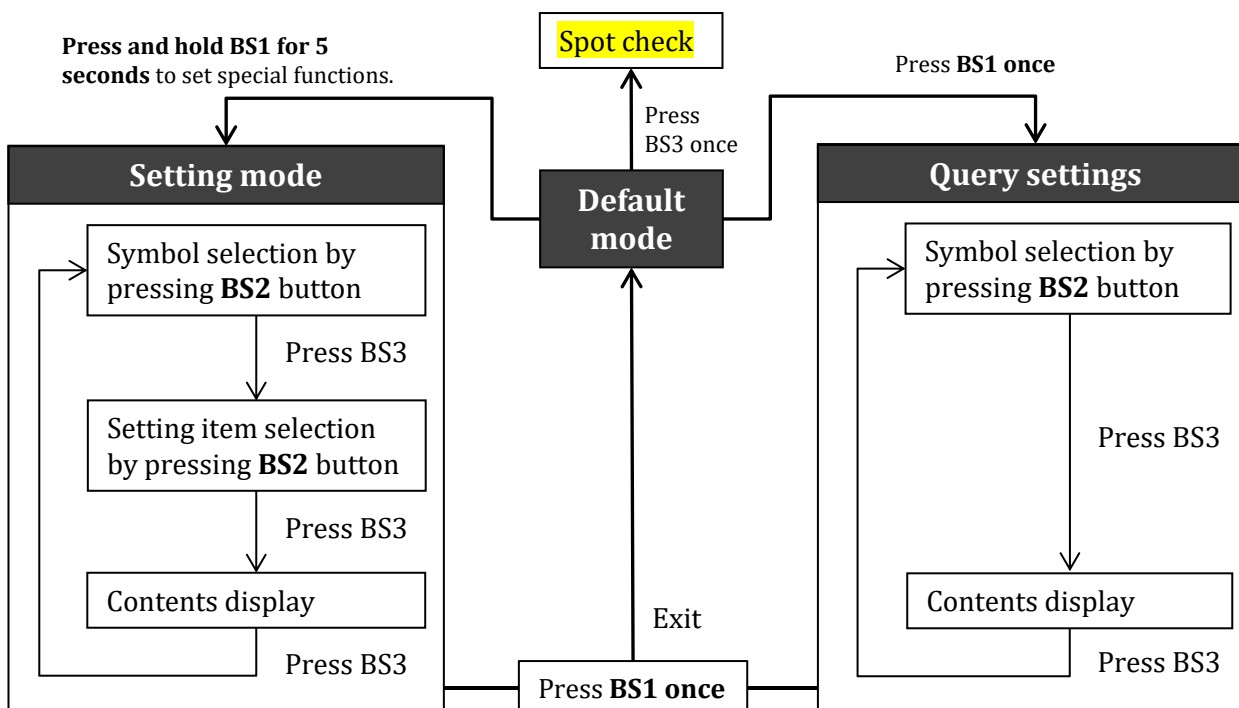

Default mode (Spot check)

System states can be showed on the 7 segments display (LED) of outdoor unit. Press **BS3** button to get code number and corresponding detailed information with an interval of one second.

Example:

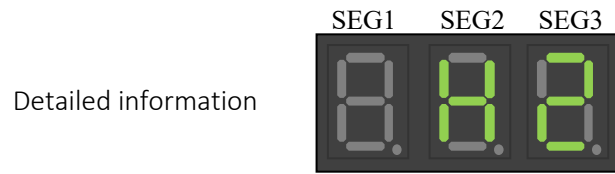

No.	Number content	Example	Description
Default	Refer to default display instructions	902	9: Command 0: Running under high pressure limit 2: Cooling mode
01-	Outdoor unit type and capacity	H3	H: heat pump C: AC only 3: 3Ton
02-	Liquid line sub-cooling	10	10°F
03-	Compressor suction superheat	18	18°F
04-	Compressor speed	56	56RPS
05-	Electronic expansion valve opening	360	360pls
06-	Step of fan	8	The 8th step
07-	Low pressure (LP sensor)	145	145psig
08-	High pressure (HP sensor)	350	350psig
09-	Outdoor ambient temp. (TA)	95	95°F
10-	Compressor suction temp. (TS)	70	70°F
11-	Compressor discharge temp. (TD)	170	170°F
12-	Defrost sensor temp. (TH)	80	80°F
13-	Liquid line temp. (TL)	70	70°F
14-	Inverter module temp. (TF)	150	150°F
15-	Target evaporating temp. (Tes)	43	43°F
16-	Current evaporating temp. (Te)	45	45°F
17-	Target condensing temp. (Tcs)	104	104°F
18-	Current condensing temp. (Tc)	112	112°F
19-	Compressor DC current	10.1	10.1A
20-	Undercharged refrigerant signal	1	0: None 1: Level 1 2: Level 2 (severe)
21-	Main software version	A01	A01 version
22-	Inverter software version	b01	b01 version
23-	Current fault	E1	Display up to 5 * codes
24-	The last fault	F1	--: None
25-	Fault before the last fault	F2	--: None
26-	Product series	2	2: B series

Remark:

When multi-error codes exist at the same time, each code will be displayed one by one with an interval of one second.

Setting mode

Press and hold **BS1** button for 5 seconds to enter the parameter setting interface. The latest setting will be taken as the final one. Refer to the following pages for some settings example.

Symbol	Function	Item	Description
n00	Mode choice	0(factory)	Normal (Energy Saving) mode
		1	Dry mode *1
		2	High capacity mode *2
n01	Forced heat pump stop when ambient temperature is lower than specified value. Switching to heat by gas furnace or boiler in cold winter. *3	0	Stop heat pump when TA<-22°F
		1(factory)	Stop heat pump when TA<-3°F
		2	Stop heat pump when TA<15°F
		3	Stop heat pump when TA<30°F
		4	Stop heat pump when TA<40°F
n02	Indoor second heater for outdoor unit outputs 24VAC at W terminal (CN5). *3	0(factory)	ON (Electric auxiliary heater)
		1(factory)	OFF (Furnace or Boiler)
n03	Outdoor unit outputs 24VAC at W terminal (CN5) when ambient temperature is lower than specified value to start indoor electric auxiliary heater. *3	0(factory)	TA<15°F (24VAC output)
		1	TA<30°F (24VAC output)
		2	TA<40°F (24VAC output)
		3	TA<-3°F (24VAC output)
		4	OFF
n04	Defrost mode setting *4	0	Defrost in heavy snow area
		1(factory)	Standard mode
		2	Defrost in light snow area
n05	Silent mode setting	0(factory)	None silent mode
		1	Silent mode (level 1)
		2	Super silent mode (level 2)
		3	Night silent mode (level 1)
		4	Night super silent mode (level 2)
n06	Night silent setting- start time	0	17:00
		1(factory)	18:00
		2	19:00
		3	20:00
		4	21:00
n07	Night silent setting- end time	0	5:00
		1(factory)	6:00
		2	7:00
		3	8:00
		4	9:00
n08	Forced defrost	0(factory)	OFF
		1	ON *5
n18	Product series setting	3	Pro series

Remarks:

1. The evaporating temperature of indoor coil can drop down to 28°F .
2. The evaporating temperature of indoor coil can drop down to 28°F in cooling mode, and the condensing temperature can go up to 122°F in heating mode.
3. N01/n02/n03 Settings do not affect the output 24V of W terminal during defrost.
4. Reduce about 10% heating time for heavy snow area, increase about 10% heating time for light snow area.
5. System enters defrost after the heating start-up and an extra five minutes' control.

Example for mode choice (n00) setting

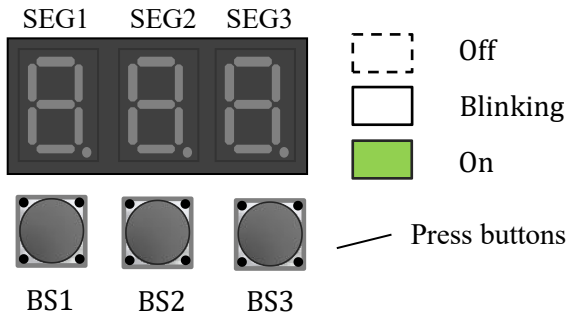

BS1: Menu or back button

BS2: UP button

BS3: Spot check and confirm button

Remarks: Press or tip any directions are valid.

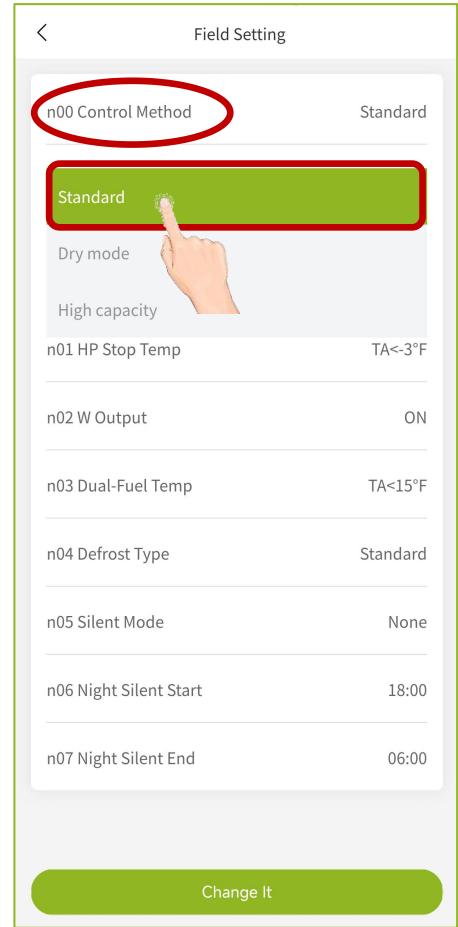

Step1
Press and hold **BS1** for 5 seconds.

Step2
Press **BS2** to select item (n00 for this case).

Step3
Press **BS3** to enter sub-item setting.

n00=0, Normal mode./ n00=1, Dry mode./ n00=2, High capacity mode.

Step4
Press **BS2** to change sub-item (n00 = 1).

Step5
Press **BS3** **twice** to save.

Step6
Press **BS1** to return.

Example for n02 & n03 (Dual-heating) setting

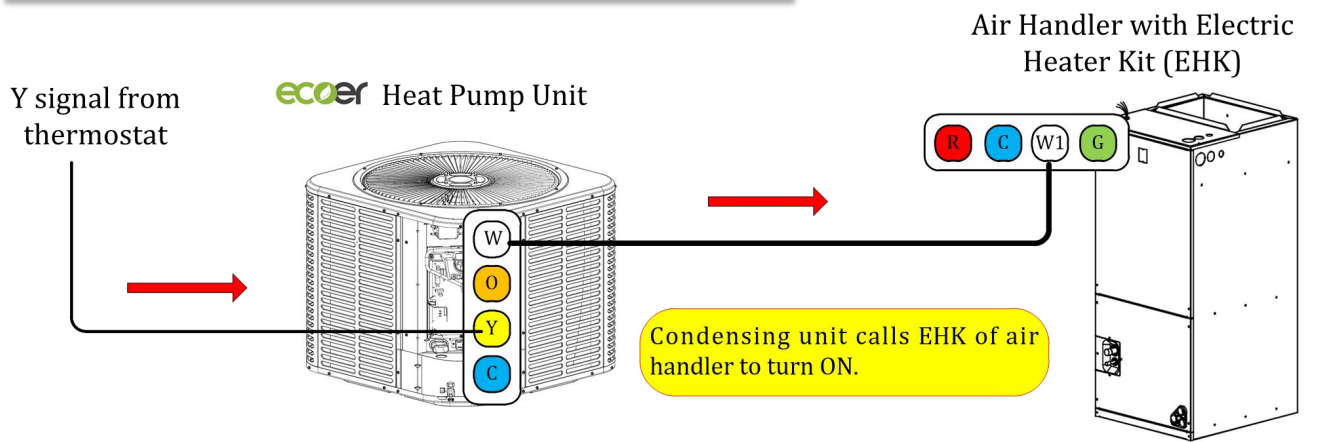

n02 Select the second heat source device type between gas furnace and electric heating.

- 0: ON (Electric auxiliary heater) --Factory
- 1: OFF(Furnace or Boiler)

n03 Outdoor W terminal outputs 24VAC once ambient temperature is lower than specific value with pretty low high pressure for backup when n02 is ON.

Only when Y signal energized with n02 set to ON.

- 0: TA<15°F (24V output) --Factory
- 1: TA<30°F (24V output)
- 2: TA<40°F (24V output)
- 3: TA<-3°F (24V output)
- 4: OFF

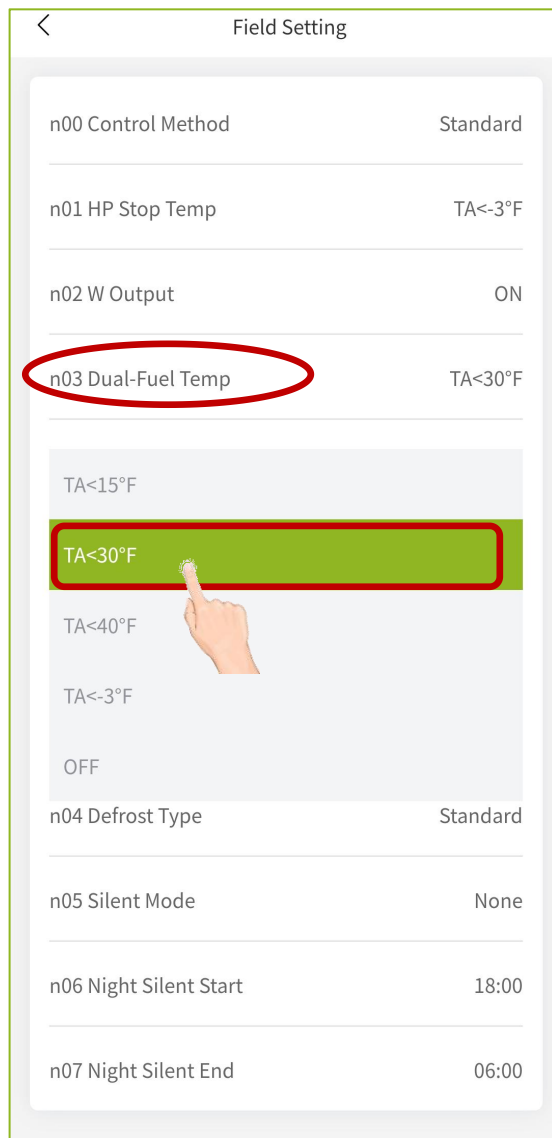

Example:

W outputs 24VAC when TA< 30°F.

n02 = 0
n03 = 1

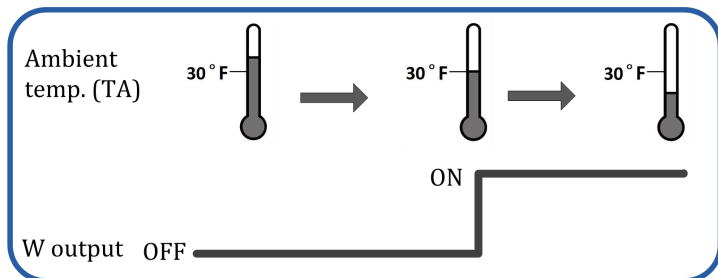

Example for n02 & n03 setting (AUTO change-over heating)

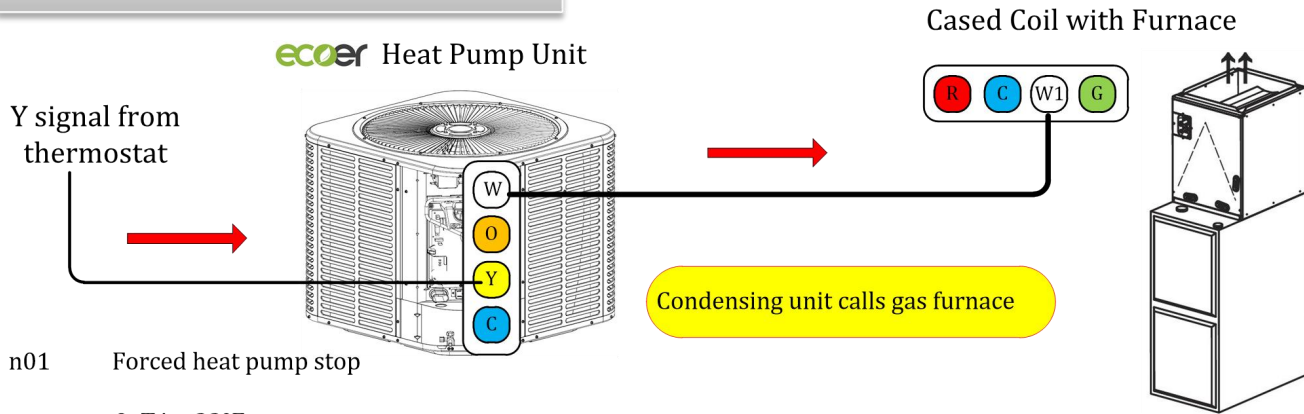

n01 Forced heat pump stop

- 0: TA<-22°F
- 1: TA<-3°F (factory)
- 2: TA<15°F
- 3: TA<30°F
- 4: TA<40°F

n02 Outdoor W terminal outputs 24VAC at defrost control or forced heat pump stop temperature.

- 0: ON (Electric auxiliary heater) --Factory
- 1: OFF(Furnace or Boiler)--Selection

n03 Outdoor W terminal outputs 24VAC once ambient temperature is lower than specific value with pretty low high pressure.

- 0: TA<15°F (24V output) --Factory
- 1: TA<30°F (24V output)
- 2: TA<40°F (24V output)
- 3: TA<-3°F (24V output)
- 4: OFF

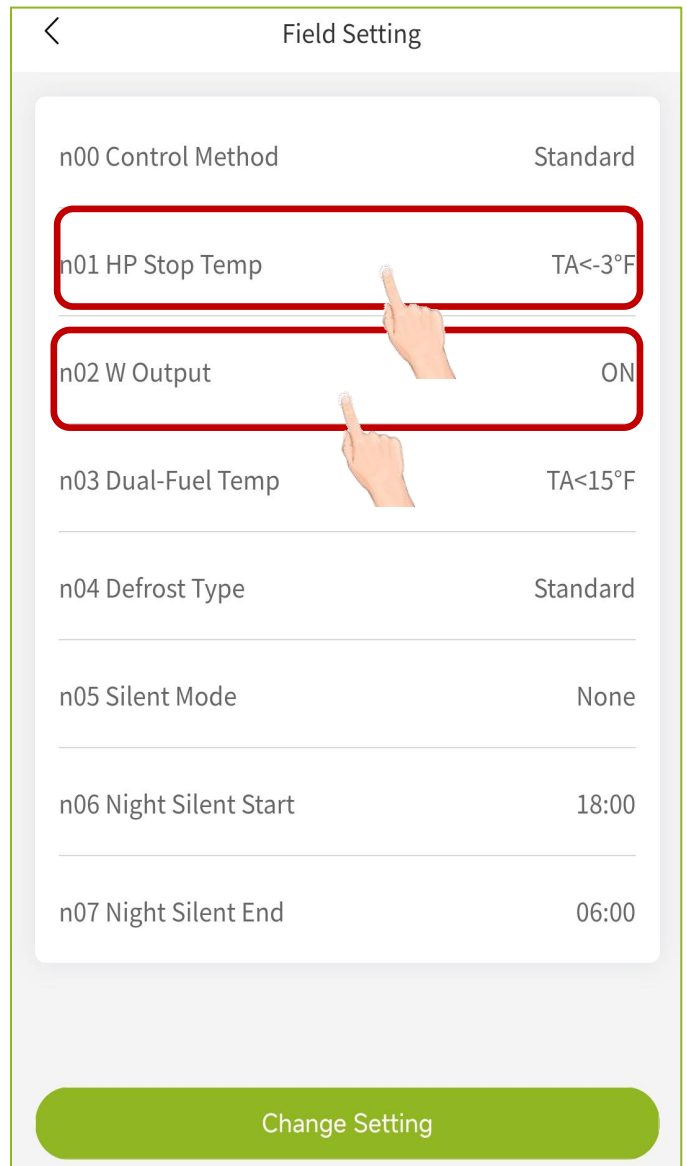

Example:

Auto change-over for furnace and heat pump at TA=30 °F

n01 = 3 **Y signal energized but heat pump won't start-up**
 n02 = 1 **Selection**
 n03 = 0

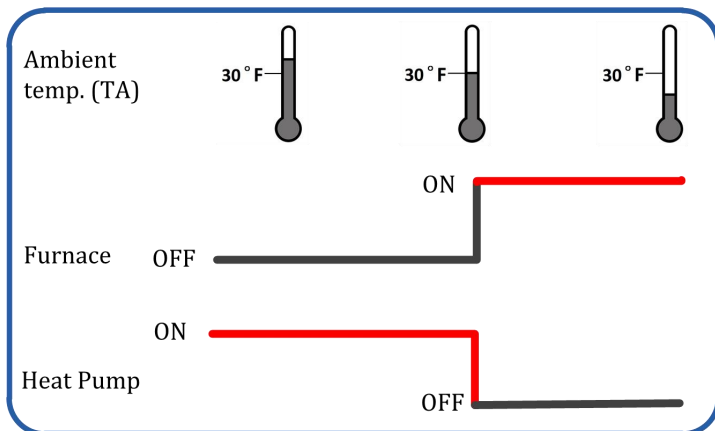

Illustration for n05 to n07 settings

Noise of silent mode is about 3 dB lower than normal mode.

Noise of super silent mode is about 6 dB lower than normal mode.

n05
Silent mode setting.

0: None silent mode --Factory
1: Silent mode (level 1)
2: Super silent mode (level 2)

3: Night silent mode (level 1)
4: Super night silent (level 2)

n06	n07
Night time setting - Start time.	Night time setting - End time.
0: 17:00	0: 5:00
1: 18:00 (Factory)	1: 6:00 (Factory)
2: 19:00	2: 7:00
3: 20:00	3: 8:00
4: 21:00	4: 9:00

Example 1: n05 = 0 n06 = N/A n07 = N/A

0:00 24:00

Normal mode

Example 2: n05 = 1 n06 = N/A n07 = N/A

0:00 24:00

Silent mode (level 1)

Example 3: n05 = 2 n06 = N/A n07 = N/A

0:00 24:00

Super silent mode (level 2)

Example 4: n05 = 3 n06 = 0 n07 = 1

0:00 24:00

Normal mode Silent mode (level 1) Normal mode

Example 5: n05 = 4 n06 = 2 n07 = 3

0:00 24:00

Normal mode Super silent mode (level 2) Normal mode

Silent mode Settings

Press **BS1** button once to query the current settings, or check it via Ecoer Smart Service Pro App.

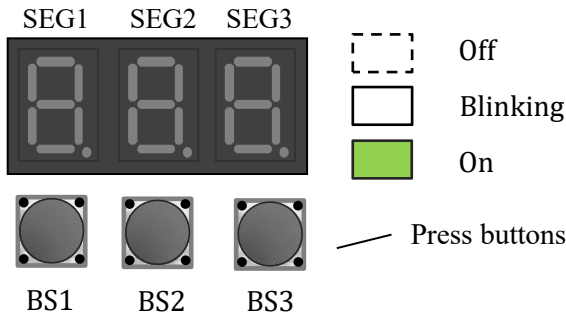

BS1: Menu or back button

BS2: UP button

BS3: Spot check and confirm button

Remarks: Press or tip any directions are valid.

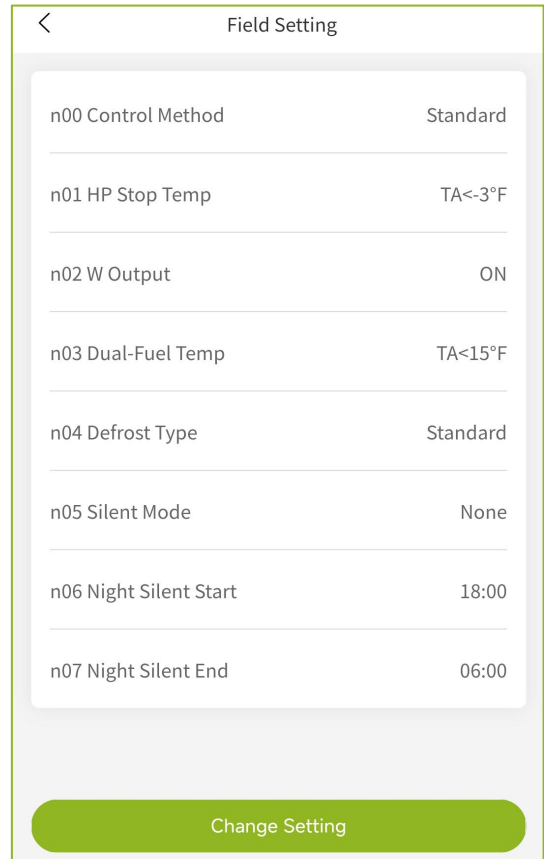

Step1
Press BS1 to enter query setting mode.

Step2
Press BS2 to select item (n05 for this case).

Step3
Press BS3 to check the current setting (n05 = 1).

Step4

Press BS3 to Step 2 for other setting check.

Press BS1 to return.

3. Troubleshooting

3.1 Problems without Codes

If the system does not operate properly besides any malfunctions. Check the system based on the following procedures.

Symptoms	Possible causes	Solutions
The unit energized but the digital tube shows nothing	<ul style="list-style-type: none"> See the following page 	<ul style="list-style-type: none"> See the following page
System does not start-up but the digital tube shows normally	<ul style="list-style-type: none"> No 24 VAC for Y signal from thermostat Incompatible thermostat 	<ul style="list-style-type: none"> Be sure Y/O/C wirings are connected correctly and the setting temperature at thermostat is proper. Use other traditional 24VAC thermostats
System operates mode reversely	<ul style="list-style-type: none"> Incorrect O/B signal selection 	<ul style="list-style-type: none"> Choose O for cooling at thermostat
System cannot cool well	<ul style="list-style-type: none"> Outside temperature is too high Outside temperature is too low Dirty air filter or blocked duct Lack of refrigerant Refrigerant has been blocked in the condenser coil 	<ul style="list-style-type: none"> Normal protection control to limit RPS Ensure the cooling loads Replace the air filter and eliminate any obstacles Check refrigerant amount or any leaks Counterclockwise the TXV (Make sure the refrigerant coefficient is 0.6)
System cannot heat well	<ul style="list-style-type: none"> Outside temperature is too low but no third-party heat inside The outdoor coil is dirty or has been covered by heavy snow Dirty air filter Micro channel (MC) coil has been used Lack of refrigerant 	<ul style="list-style-type: none"> Install auxiliary heat for back-up *Dual-heating is recommended Clean the outdoor coil Replace the air filter No MC coils shall be used for heat pump Check refrigerant amount or any leaks

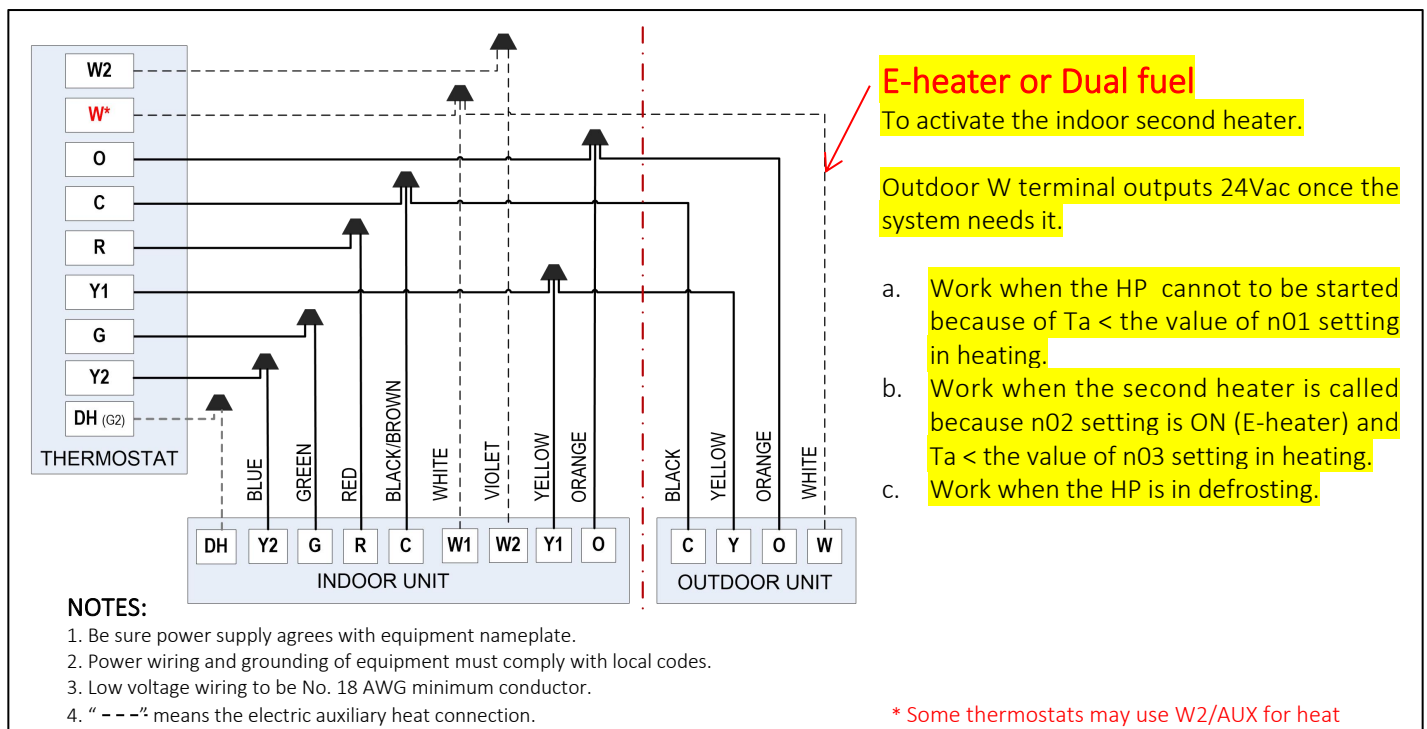

No Display

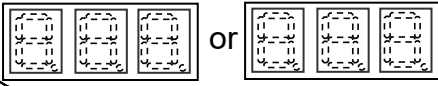

The unit energized but the digital tube shows nothing

1.Error definition:

No display on main control board even though the unit has been powered ON.

2.Possible causes:

- Damaged noise filter
- Damaged inductance
- Loose connection at port on main control board
- Damaged pressure sensor
- Damaged fan motor
- Damaged main control board

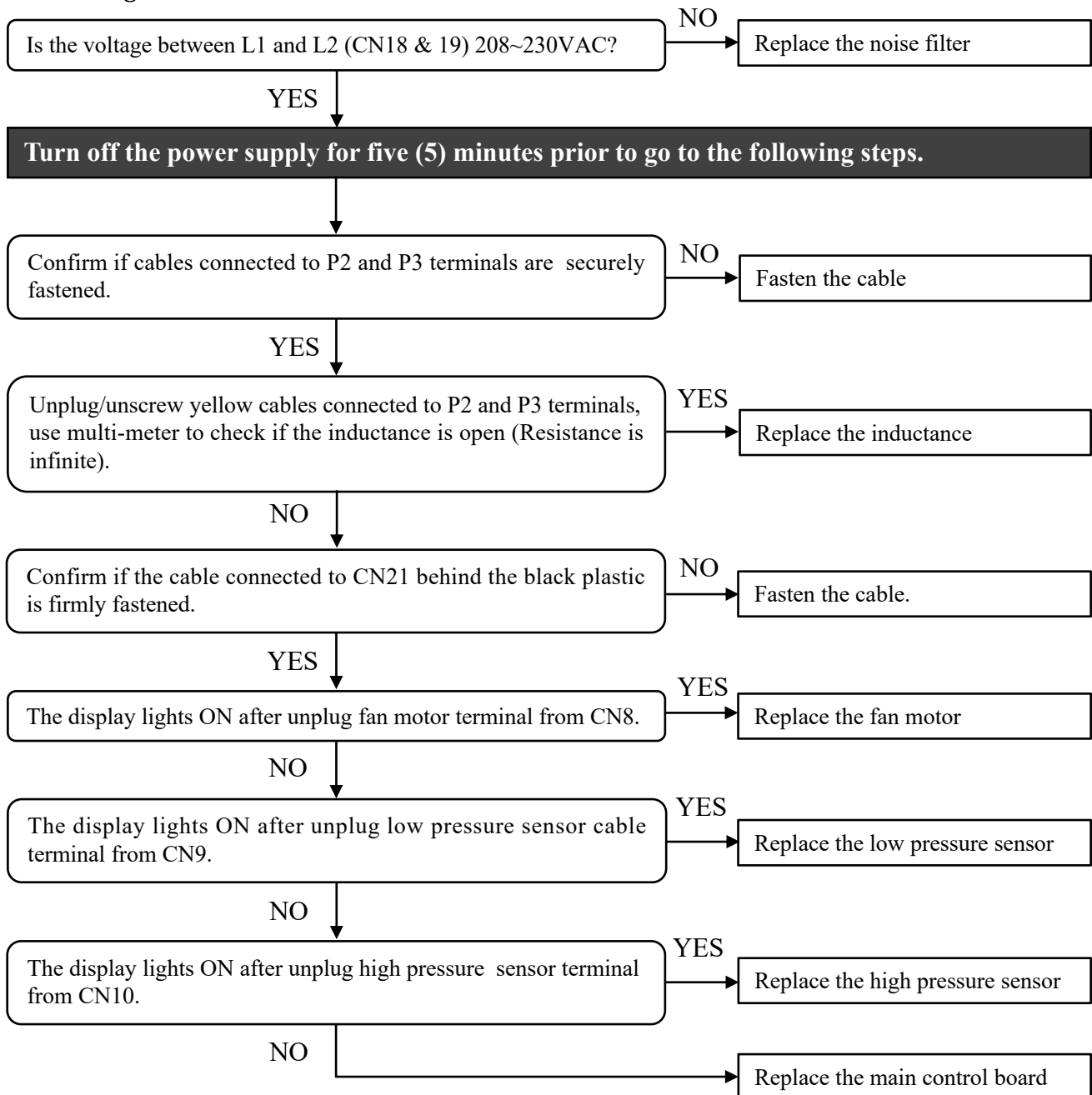

3.2 Error Codes List

Past error codes can be inquired by **BS3** button, and viewed on Ecoer Smart Service Pro App.

Code	Description	Legend	Page
P1	High pressure protection		
E1	System locks up when P1 has occurred six times in 3 hours.	Cannot restart *1	
P2	Low pressure protection in cooling mode		
E2	System locks up when P2 has occurred six times within 3 hours.	Cannot restart *1	
P3	Compressor discharge temperature (TD) protection		
E3	System locks up when P3 has occurred six times within 3 hours.	Cannot restart *1	
P4	Compressor discharge temp. (TD) sensor is disconnected or damaged		
P5	Inverter module temperature (TF) protection		
E5	System locks up when P5 has occurred six times within 3 hours.	Cannot restart *1	
P6	Compressor over-current protection		
E6	System locks up when P6 has occurred six times within 3 hours.	Cannot restart *1	
P7	Liquid slugging protection		
E7	System locks up when P7 has occurred three times within 5 hours.	Cannot restart *1	
P8	Low compressor voltage protection		
E8	System locks up when P8 has occurred three times within 60 minutes.	Cannot restart *1	
P9	Incorrect compressor line sequence	Cannot restart *1	
PA	DC fan motor over-load protection	Cannot restart *1	
F1	Ambient temperature (TA) sensor fault	back-up running*2	
F2	Compressor suction temperature (TS) sensor fault	back-up running*2	
F3	Liquid line temperature (TL) sensor fault	back-up running*2	
F4	Defrost temperature (TH) sensor fault	back-up running*2	
F5	Compressor discharge temperature (TD) sensor fault	back-up running*2	
F6	Inverter module temperature (TF) sensor fault	back-up running*2	
F7	High pressure (HP) sensor fault	back-up running*2	
F8	Low pressure (LP) sensor fault	back-up running*2	
E4	Communication fault between main chip and INV drive chip	Cannot restart *1	
H0	Heavy undercharge limit operation		
H1	Ambient temperature limit operation in cooling mode		
H2	Ambient temperature limit operation in heating mode		
H3	Abnormal switch alarm for reversing valve	Alarm	
H4	Defrost temperature (TH) sensor is disconnected or damaged		
H5	EEPROM fault		
H6	Low voltage alarm		
HF	Abnormal function control	Alarm	
C0-CC	Compressor INV module protection		
E0	System locks up when C0~CA has occurred 3 times within 60 minutes.	Cannot restart *1	

Remarks:

1. Disconnect power supply switch for 5 minutes to reset, then turn on power supply for the unit.
2. Unit goes to back-up running under sensors fault varies from 7 to 120 days. Allow up to two sensors back-up running at the same time.

Display

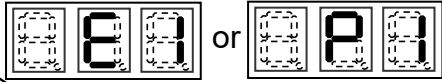

High pressure protection

1.Error definition:

P1: The detected high pressure is no less than 566psig.

E1: System locks up when P1 has occurred six times within 3 hours.

2.Possible causes:

- Service valves are closed
- The system has been severely over-charged
- Dirty/Clogged heat exchanger of outdoor unit in cooling mode
- Dirty indoor air filter or micro channel coil has been used for heat pump
- The refrigerant blocked in high pressure zone because of damaged TXV/EEV
- **The Dual Fuel setting is incorrect, causing the furnace and heat pump to run simultaneously.**
- Damaged indoor fan motor or G signal lost resulting in indoor unit FAN stops in heating
- Damaged high pressure sensor
- Damaged main control board

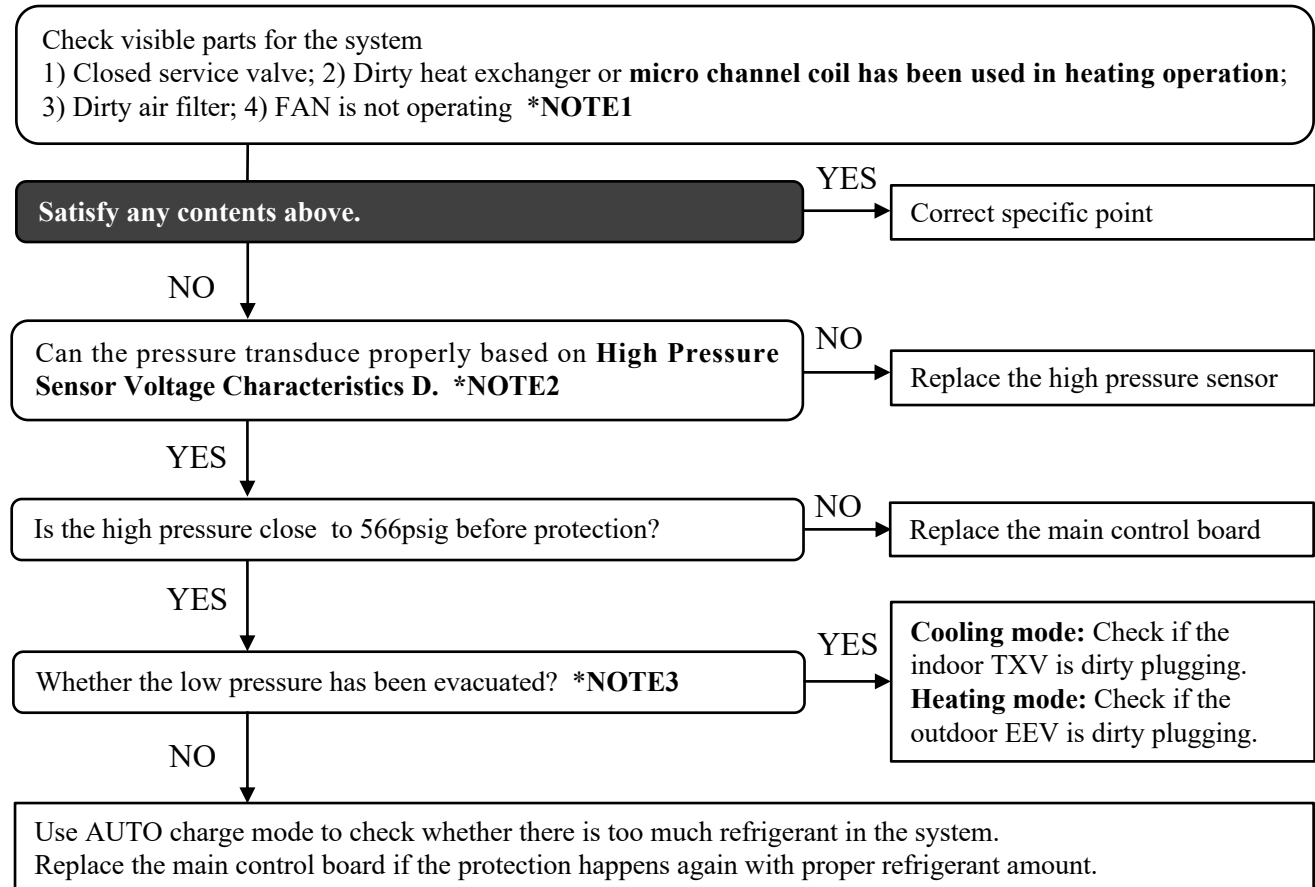

NOTES:

1. It's normal control if heating oil return operation is enforced to execute even though the Y signal=OFF (Indoor fan stops because there is No G signal). **Or connect R and G together to judge if the fan works. Yes-> Replace the indoor PCB; No-> Replace the indoor motor.**
2. Connect a pressure gauge to liquid service valve in cooling mode, gas service valve in heating mode. Compare the value difference between gauged pressure and the transduced one by high pressure sensor (spot check by BS3 button or check the data from ESS Pro App).
3. Abnormal TXV/EEV will lead to the refrigerant blockage in the high pressure side.

Display

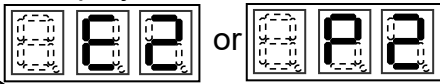

Low pressure protection in cooling mode

1.Error definition:

P2: The detected low pressure in cooling mode is less than 24.5psig.

E2: System locks up when P2 has occurred six times within 3 hours.

2.Possible causes:

- Service valves are closed
- Dirty air filter or indoor heat exchanger
- Outside temperature is lower than 40°F
- Too little refrigerant in the system
- Damaged indoor R410A TXV
- Damaged low pressure sensor
- Damaged main control board

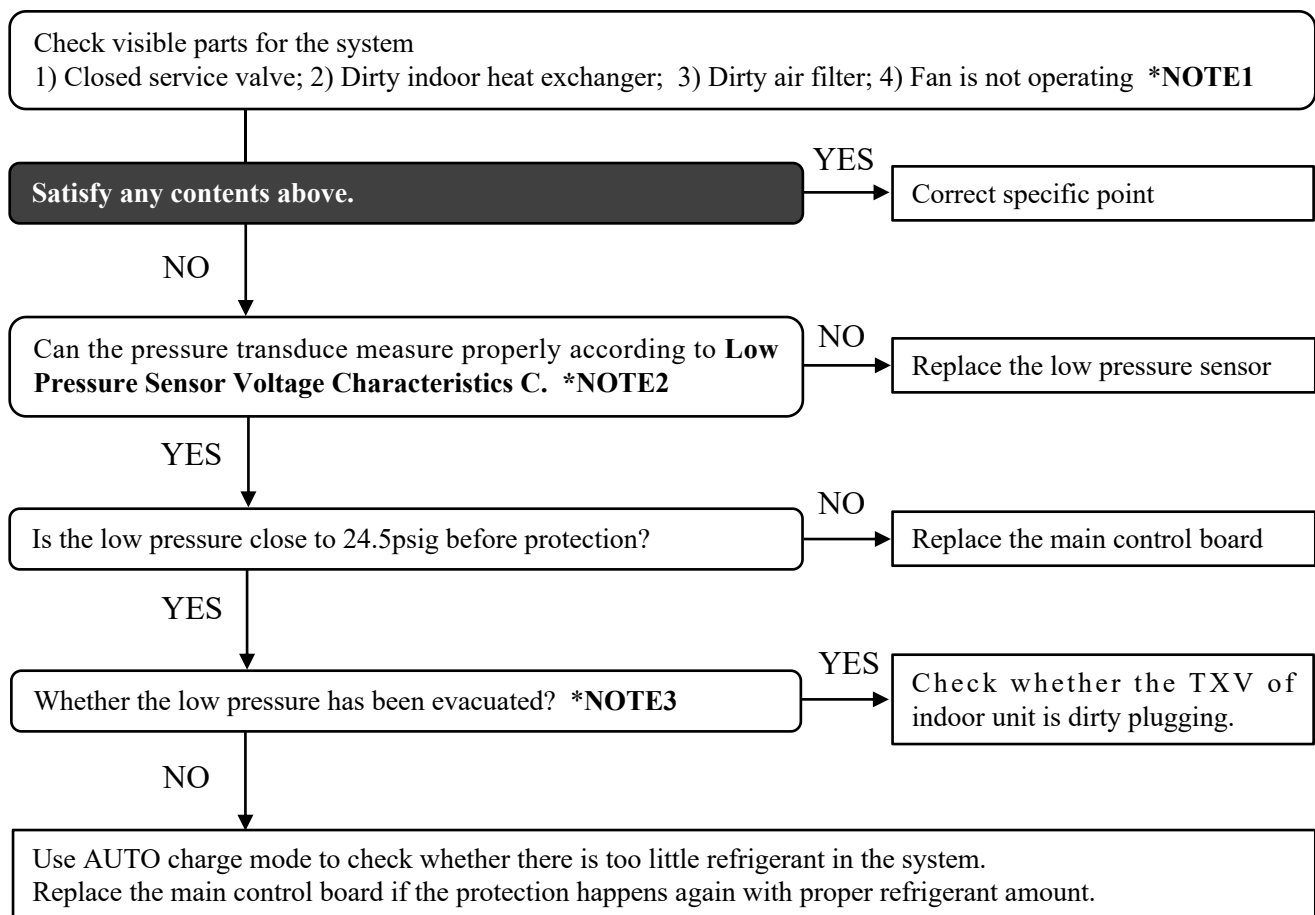

NOTES:

1. It's normal control if cooling oil return operation is enforced to execute even though the Y signal=OFF (Indoor fan stops because there is No G/G2 signal). **Or connect R and G (G2) together to judge if the fan works. Yes-> Replace the indoor PCB; No-> Replace the indoor motor.**
2. Connect a pressure gauge to gauge port, compare the difference between the gauged pressure and the transduced one by low pressure sensor (spot check by BS3 button or check the data from ESS Pro App).
3. Abnormal TXV will lead to the refrigerant blockage in the high pressure side.

Display

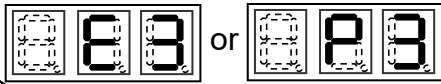

Compressor discharge temperature (TD) protection

1.Error definition:

P3: The detected discharge temperature(TD) is no less than specified value.

Cooling: 248°F Heating: 230°F

E3: System locks up when P3 has occurred six times within 3 hours.

2.Possible causes:

- Too little refrigerant remains in the system
- Dirty plugging of EEV or indoor TXV
- **Incorrect TXV type causes high temperature in heating**
- Damaged discharge temperature sensor
- Damaged main control board

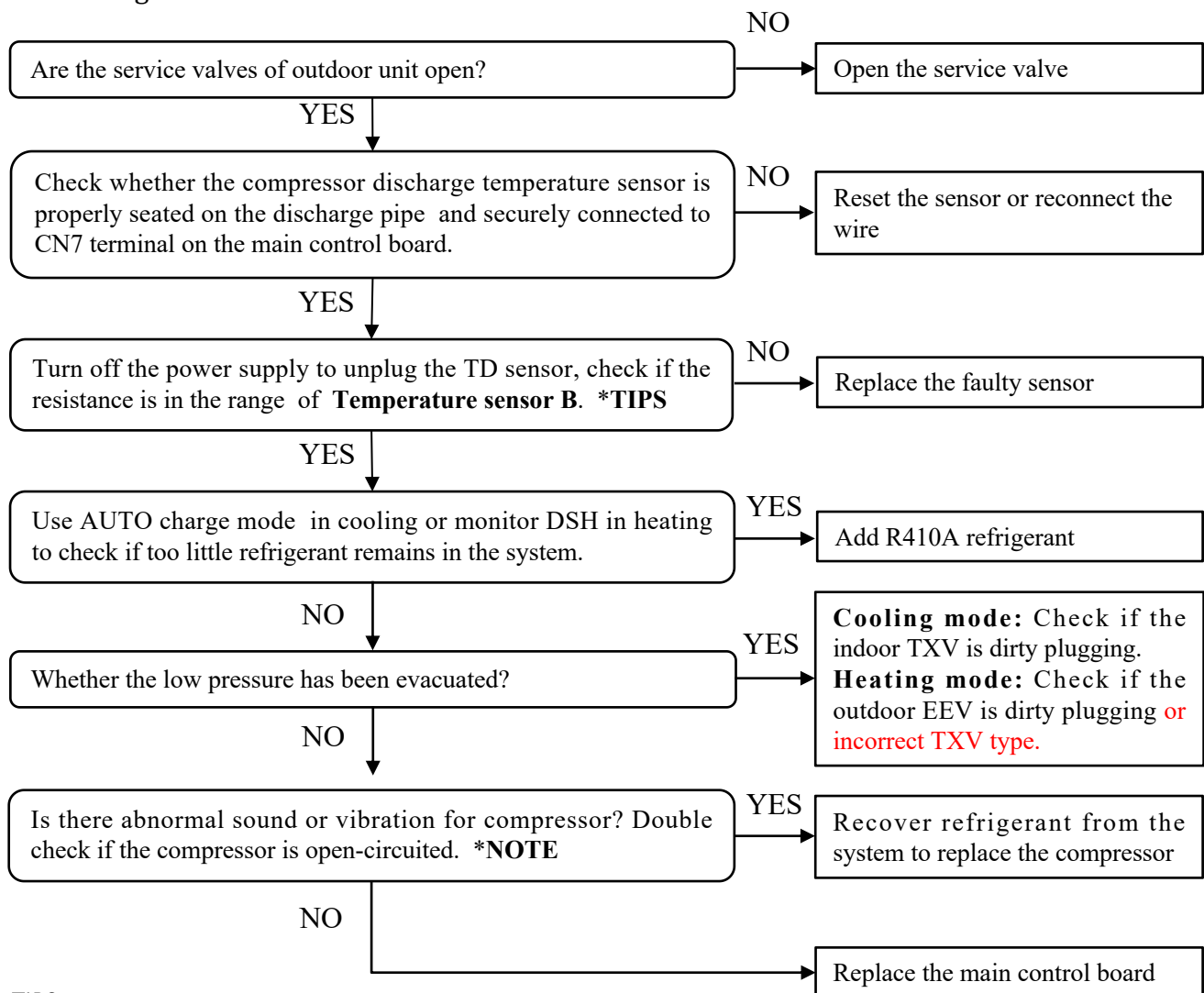

TIPS:

Technically measure the DC voltage of the temperature sensor also works when outdoor unit powers on.

NOTE: Normal resistance for compressor

3-phase resistance (UV, UW, VW) for compressor is less than 5Ω.

The insulation resistance (any phase to Ground) for compressor is greater than 100KΩ.

Display

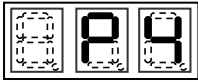

Compressor discharge temperature (TD) sensor is disconnected or damaged

1.Error definition:

Compressor discharge temperature (TD) sensor is disconnected or damaged.
 $TD < T_c - 9^{\circ}\text{F}$ for 20 minutes, T_c means the condensing temperature.

2.Possible causes:

- Discharge temperature (TD) sensor is disconnected or damaged
- Loose connection to CN7 terminal on main control board
- Damaged main control board
- There are other heat sources around the sensor

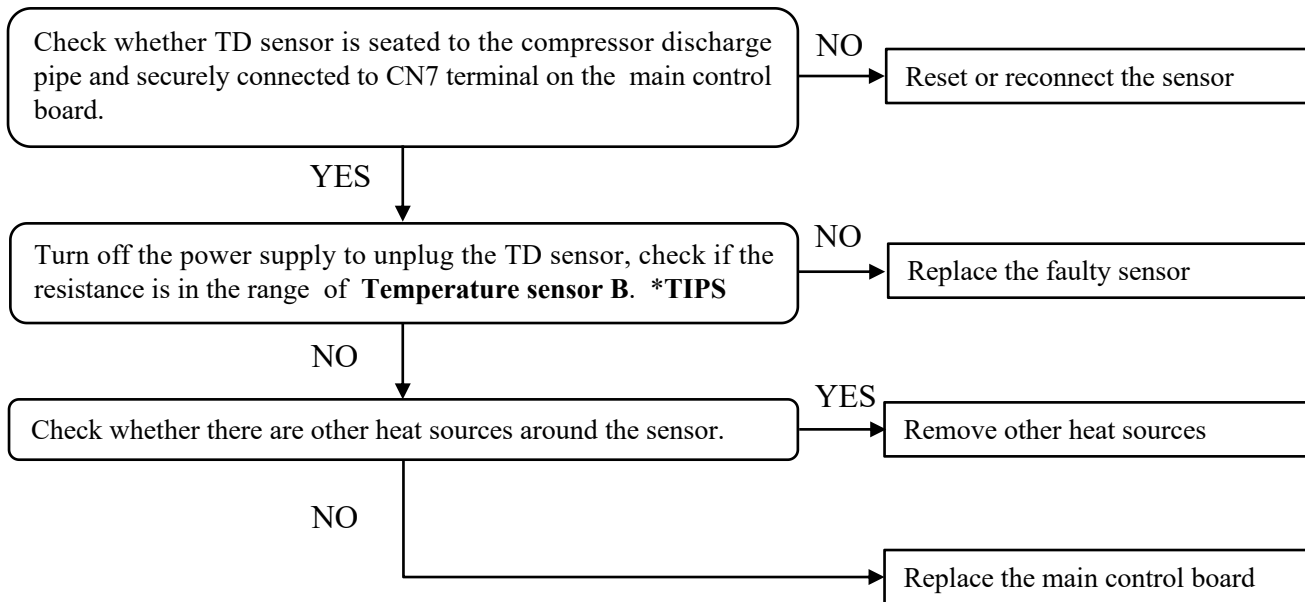

TIPS:

Technically measure the DC voltage of the temperature sensor also works when outdoor unit powers on.

Display

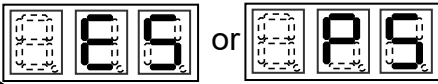

Inverter module temperature (TF) protection

1.Error definition:

P5: The detected value of module temperature (TF) is no less than specified value.

EODA18H-2436B: 199°F in cooling mode/ 185°F in heating mode

EODA18H-4860B: 203°F in cooling mode/ 185°F in heating mode

E5: System locks up when P5 has occurred six times within 3 hours.

2.Possible causes:

- Clogged fin of radiator resulting in poor heat transfer
- Dirty and blocked outdoor heat exchanger
- Damaged TF sensor(**PCB2.0 built-in TF sensor**)
- Misjudgment caused by resistance drift of TF sensor
- Damaged main control board

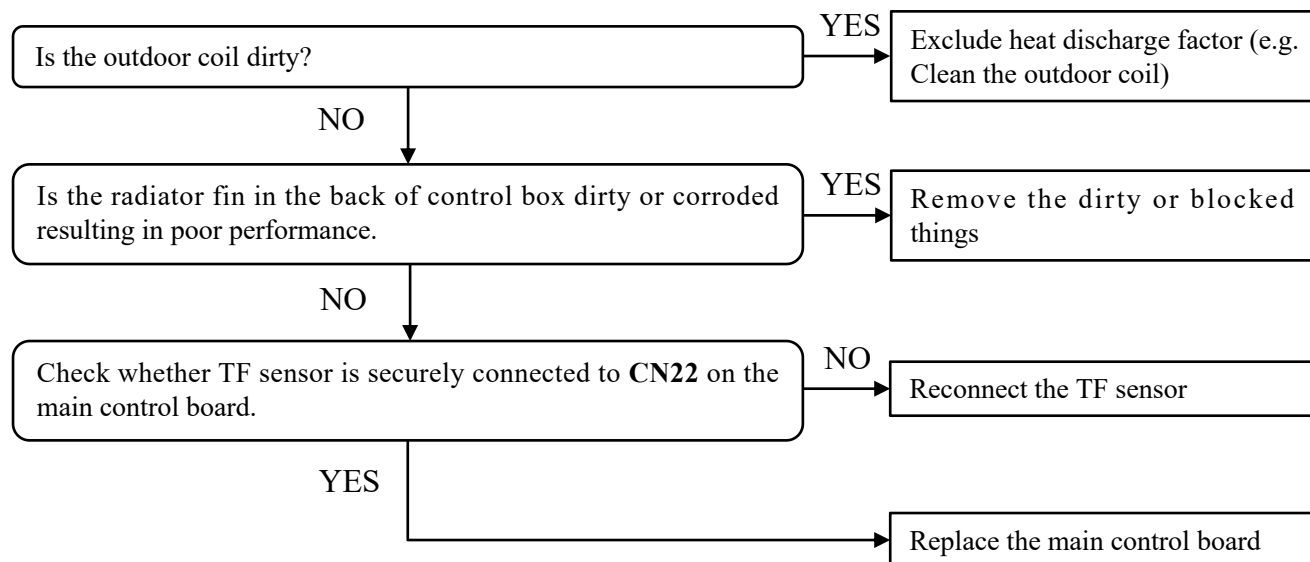

TIPS:

Technically measure the DC voltage of the temperature sensor also works when outdoor unit powers on.

Display

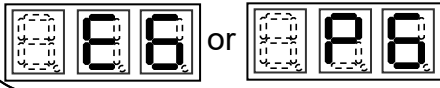

Compressor over-current protection

1.Error definition:

P6: The detected compressor current is over the maximum allowed value.

EODA18H-2436B: 14A

EODA18H-4860B: 20A

E6: System locks up when P6 has occurred six times within 3 hours.

2.Possible causes:

- Abnormal power supply voltage
- Too much refrigerant in the system resulting in liquid slugging at compressor
- Damaged main control board
- Indoor unit is suddenly powered off
- Damaged compressor

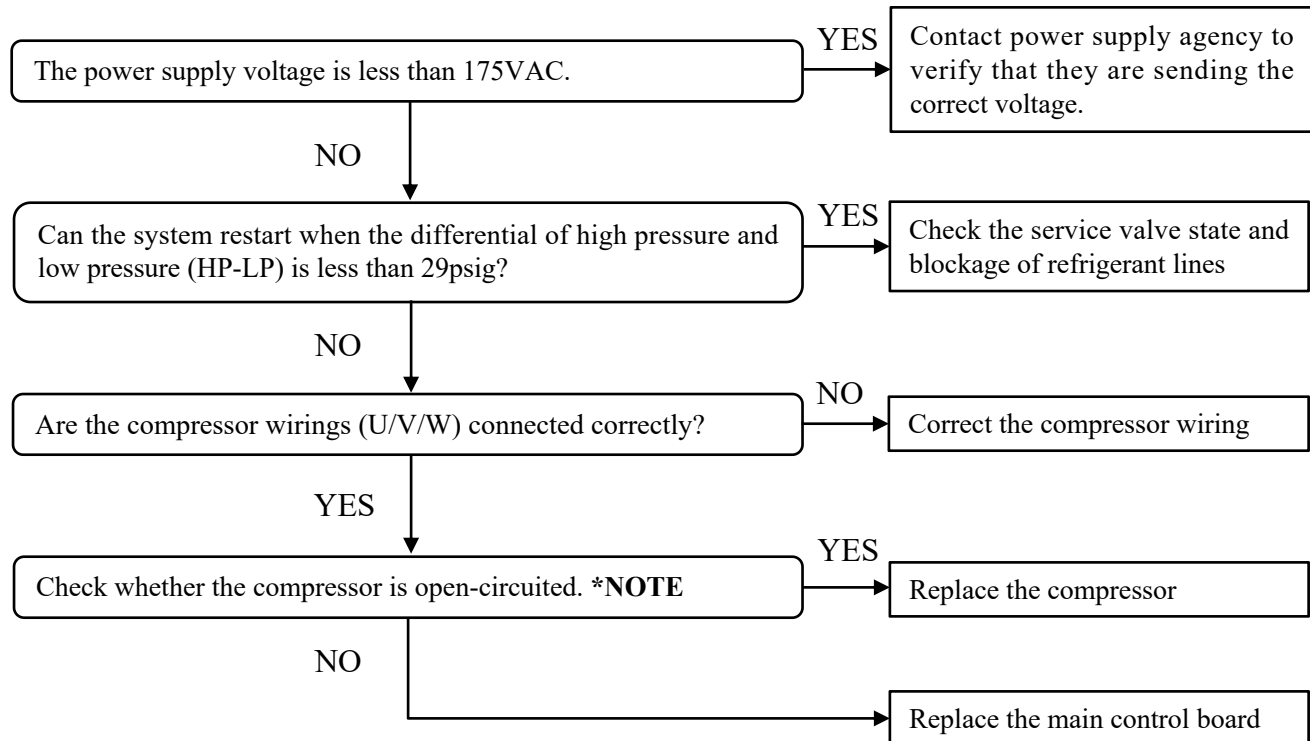

NOTE: Normal resistance for compressor

3-phase resistance (UV, UW, VW) for compressor is less than 5Ω.

The insulation resistance (any phase to Ground) for compressor is greater than 100KΩ.

Display



Liquid slugging protection

1.Error definition:

This control is to prevent compressor from damaging because of liquid slugging. When $SH < 9.0^{\circ}\text{F}$ and compressor discharge superheat ($DSH = TD - SC - TL - 1.8$) $< 14.4^{\circ}\text{F}$ for 20 minutes, starting to accumulate the liquid slugging time. Report P7 once it lasts for 30 minutes. E7: System locks up when P7 has occurred three times in 5 hours.

2.Possible causes:

- Damaged or improper TXV for indoor unit in cooling mode
- Abnormal low frequency heating operation
- Overcharged refrigerant
- Damaged discharge temperature (TD) sensor
- Damaged EEV of outdoor unit in heating mode
- Damaged main control board

Cooling mode

Connect a pressure gauge at the gas service valve to calculate suction line superheat.

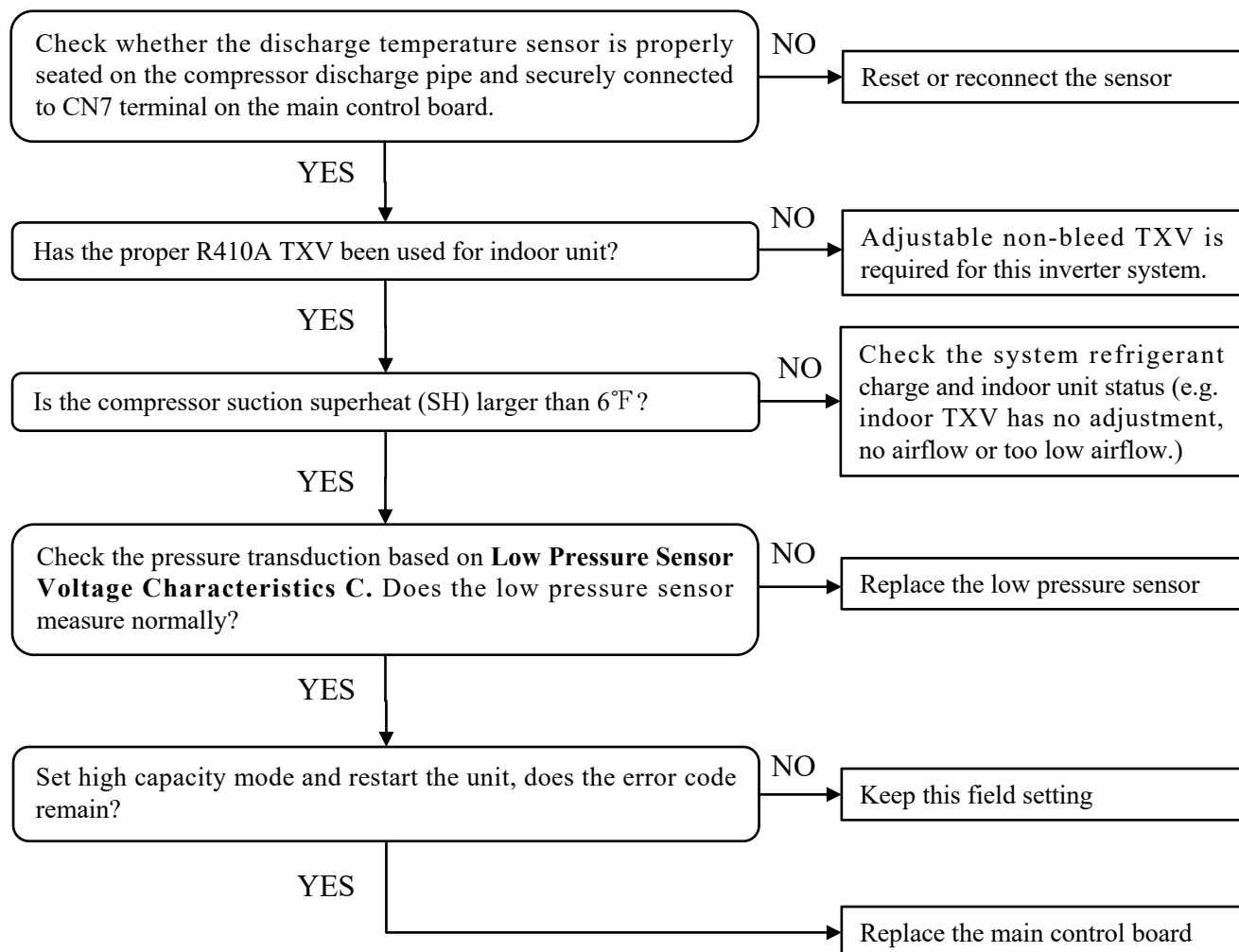

Display

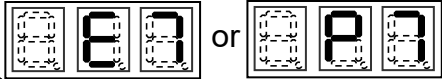

Liquid slugging protection

Heating mode

Connect a pressure gauge to liquid service valve, compare the gauged pressure with the transduced one by high pressure sensor.

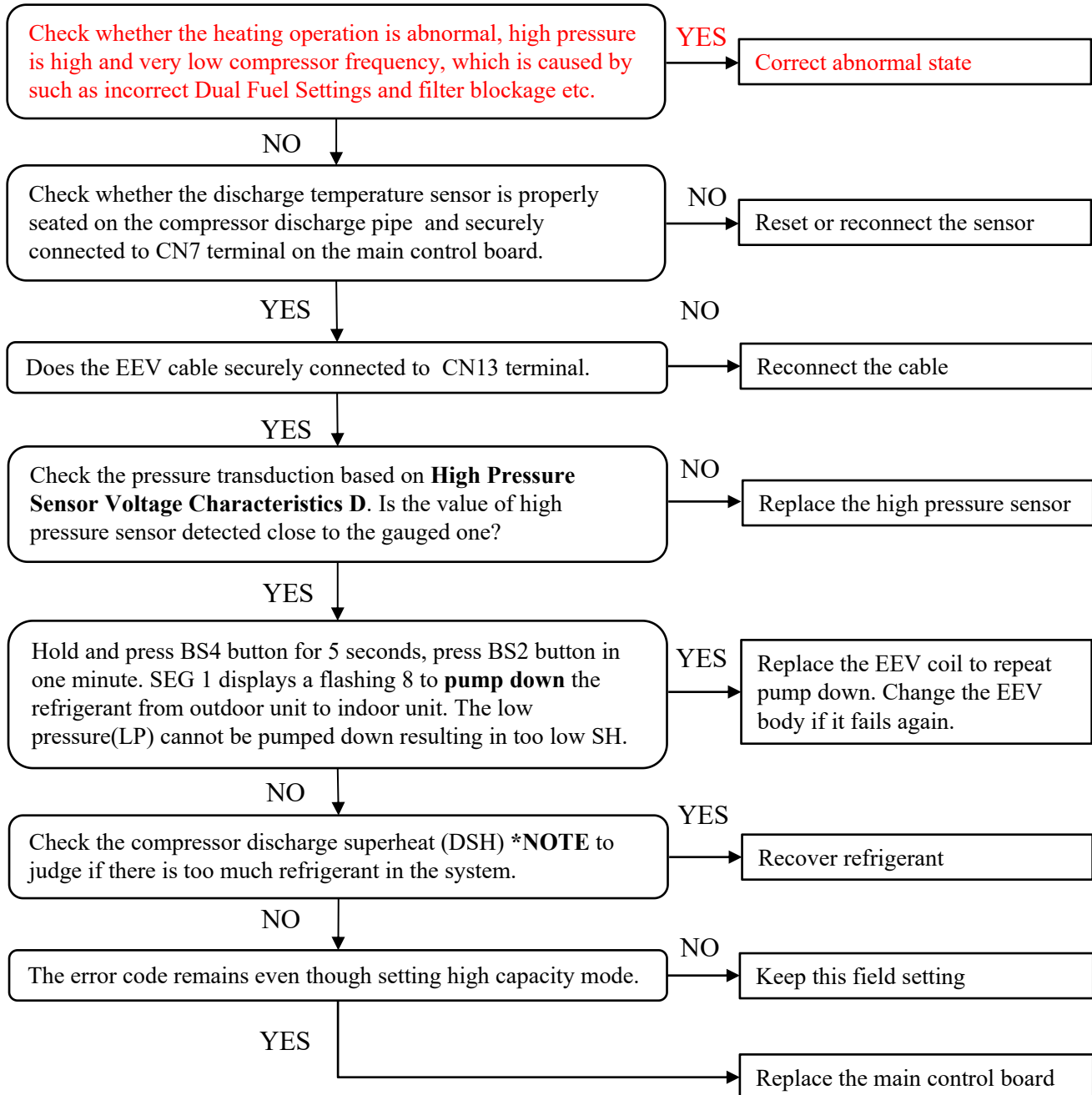

NOTE:

Heating DSH should be between 25 ° F and 60 ° F with proper refrigerant charge in normal control.

Overcharged: DSH is smaller than 18 ° F when the EEV opening < 72pls.

Undercharged: DSH is bigger than 60 ° F when the EEV opening ≥460pls



Display  **Low compressor voltage protection**

1.Error definition:

P8: The detected compressor voltage by main chip is less than 310VDC.

E8: System locks up when P8 has occurred three times in 60 minutes.

2.Possible causes:

- Abnormal power supply voltage
- Damaged main control board

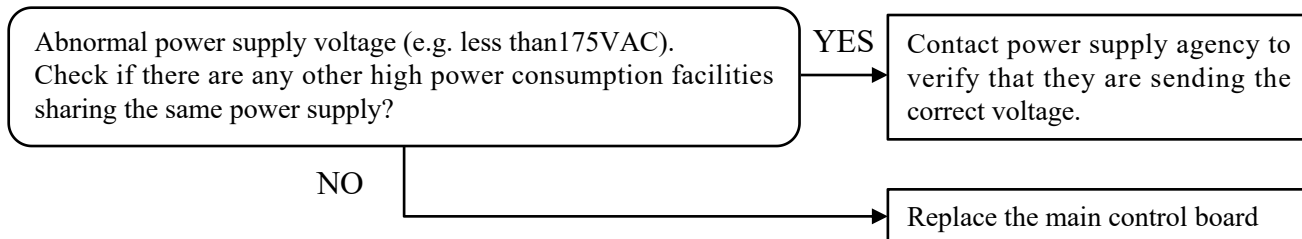

Display  **Incorrect compressor line sequence**

1.Error definition:

The detected compressor line sequence is incorrect for it's difficult to build pressure difference.

2.Possible causes:

- Damaged pressure sensor
- Incorrect U/V/W connections between main control board and compressor terminals
- Damaged EEV or indoor TXV
- Damaged main control board

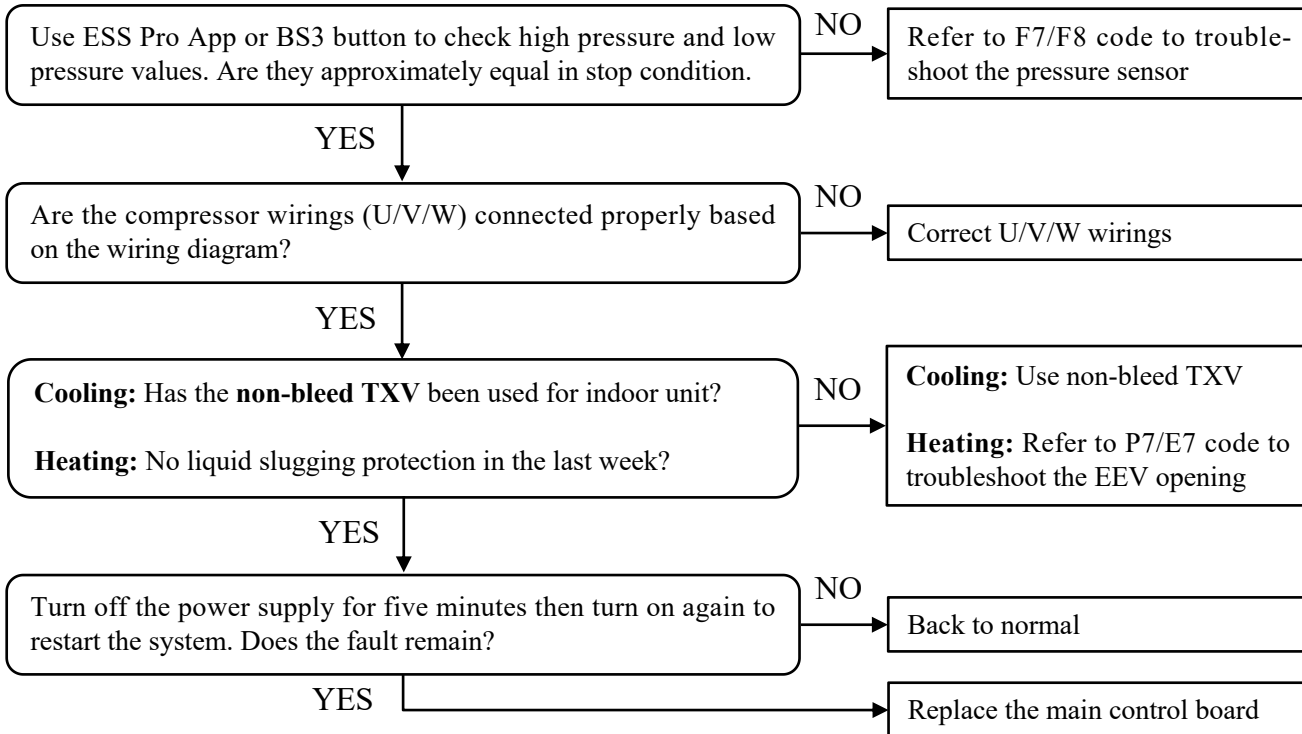

Display

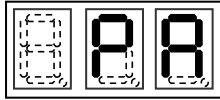

DC fan motor over-load protection

1.Error definition:

- The fan rotation speed is less than 240RPM if it has the running signal.
- The rotation speed difference between the detected value and target one is over 200RPM for 3 minutes.

2.Possible causes:

- Damaged main control board
- Malfunction of fan motor
- The unit is undergoing hurricane
- Disconnected wiring between fan motor and main control board

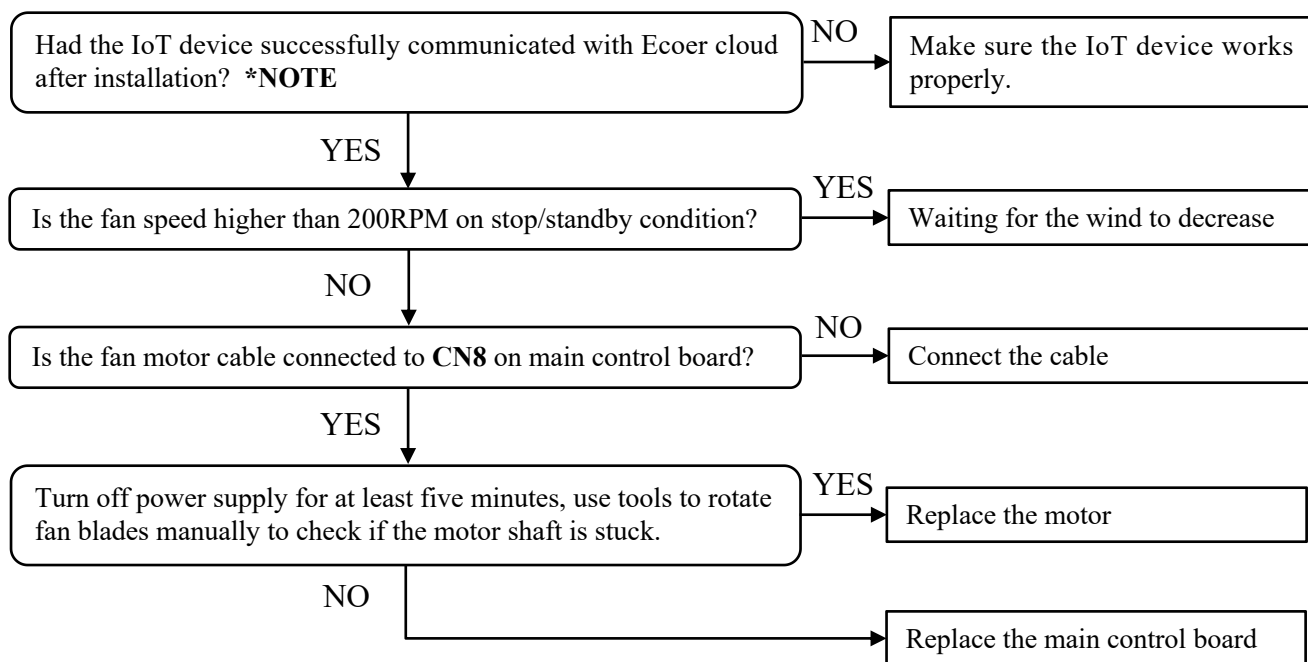

NOTE: The normal working state of IoT device should be blue LED (No.1) is blinking with other LEDs are off.



Display  **Ambient temperature (TA) sensor fault**

1.Error definition:

The outside temperature (TA) sensor is short circuit or open circuit.

2.Possible causes:

- Damaged main control board
- Loose connection at port on main control board
- Damaged temperature sensor
- There are other heat sources around the sensor

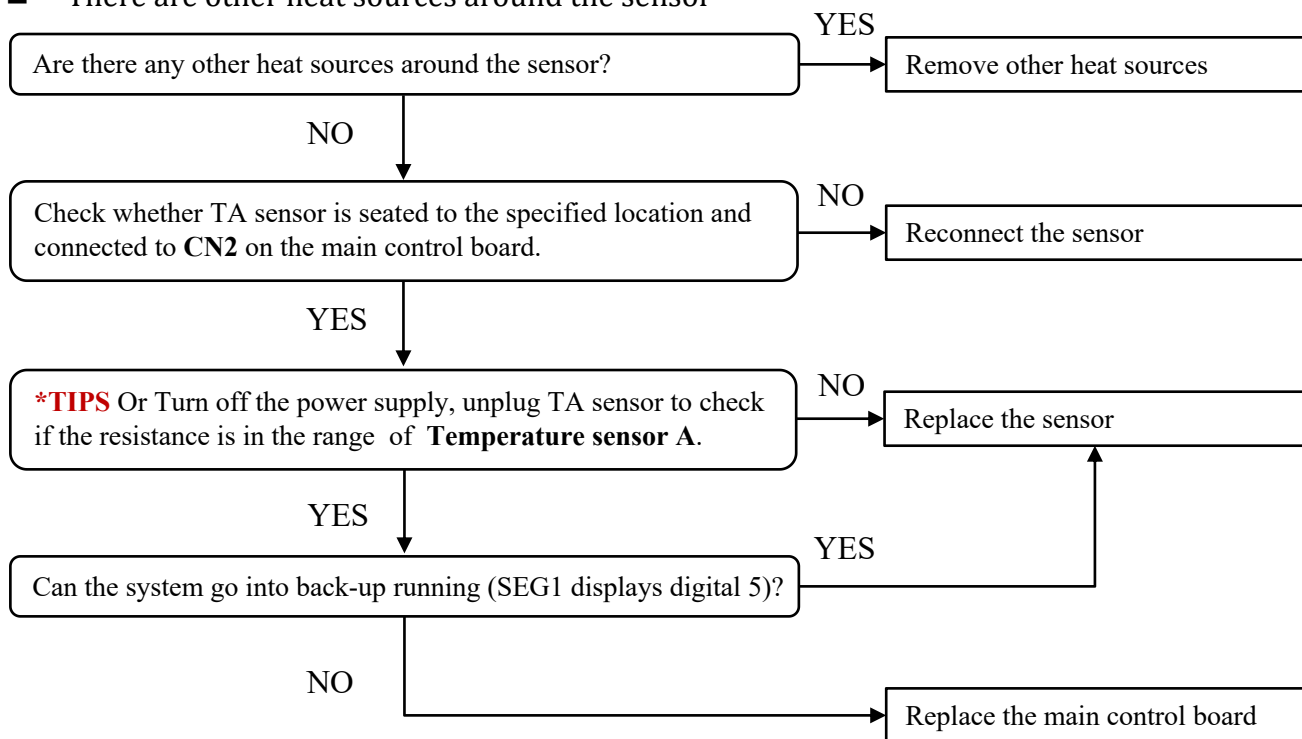

TIPS: Measure the DC voltage of the temperature sensor when outdoor unit powers on.

How to take out the protection cover for TA sensor?

STEP1. Press the button



STEP2. Push down the protection cover



STEP3. Take out the protection cover



Display

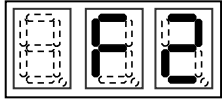

Compressor suction temperature (TS) sensor fault

1.Error definition:

The suction temperature (TS) sensor is short circuit or open circuit.

2.Possible causes:

- Damaged main control board
- Loose connection at port on main control board
- Damaged temperature sensor (TS)
- There are other heat sources around the sensor

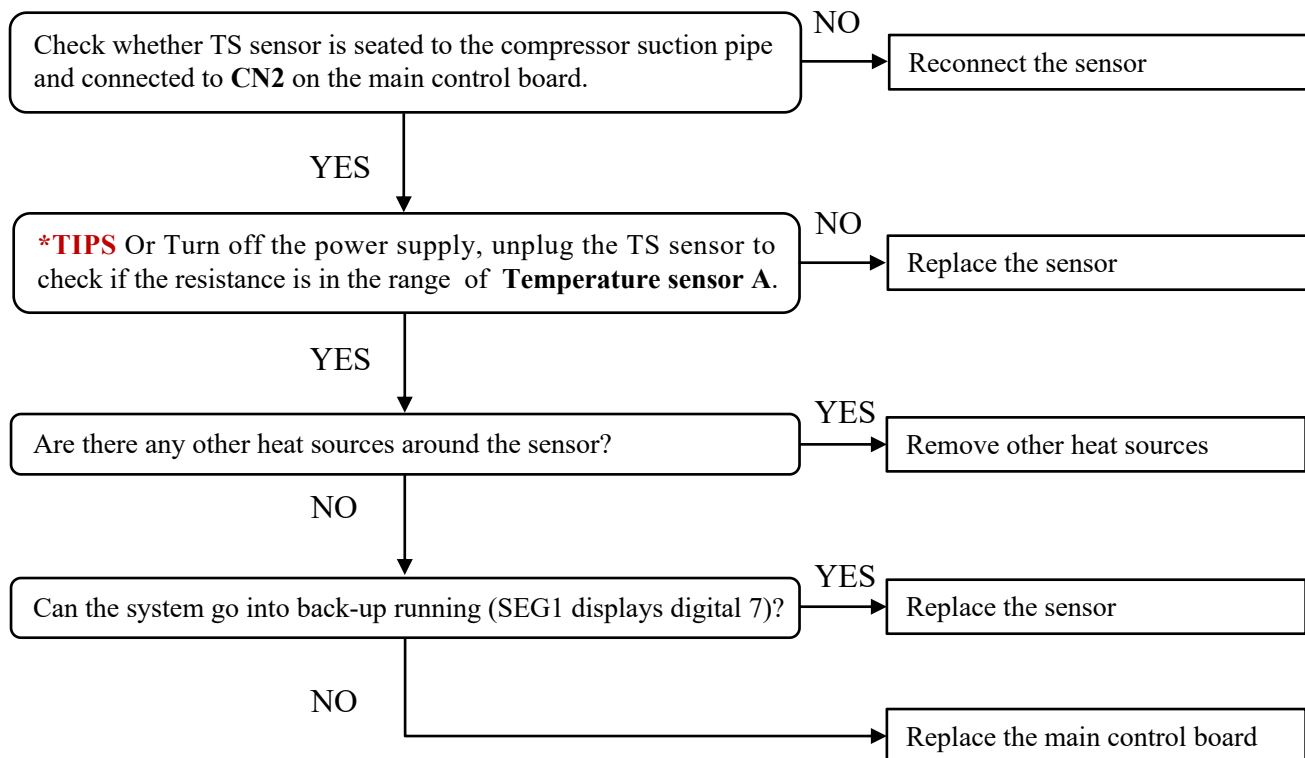

TIPS: Measure the DC voltage of the temperature sensor when outdoor unit powers on.

Display

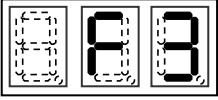

Liquid line temperature (TL) sensor fault

1.Error definition:

The liquid temperature (TL) sensor is short circuit or open circuit.

2.Possible causes:

- Damaged main control board
- Loose connection at port on main control board
- Damaged temperature sensor
- There are other heat sources around the sensor

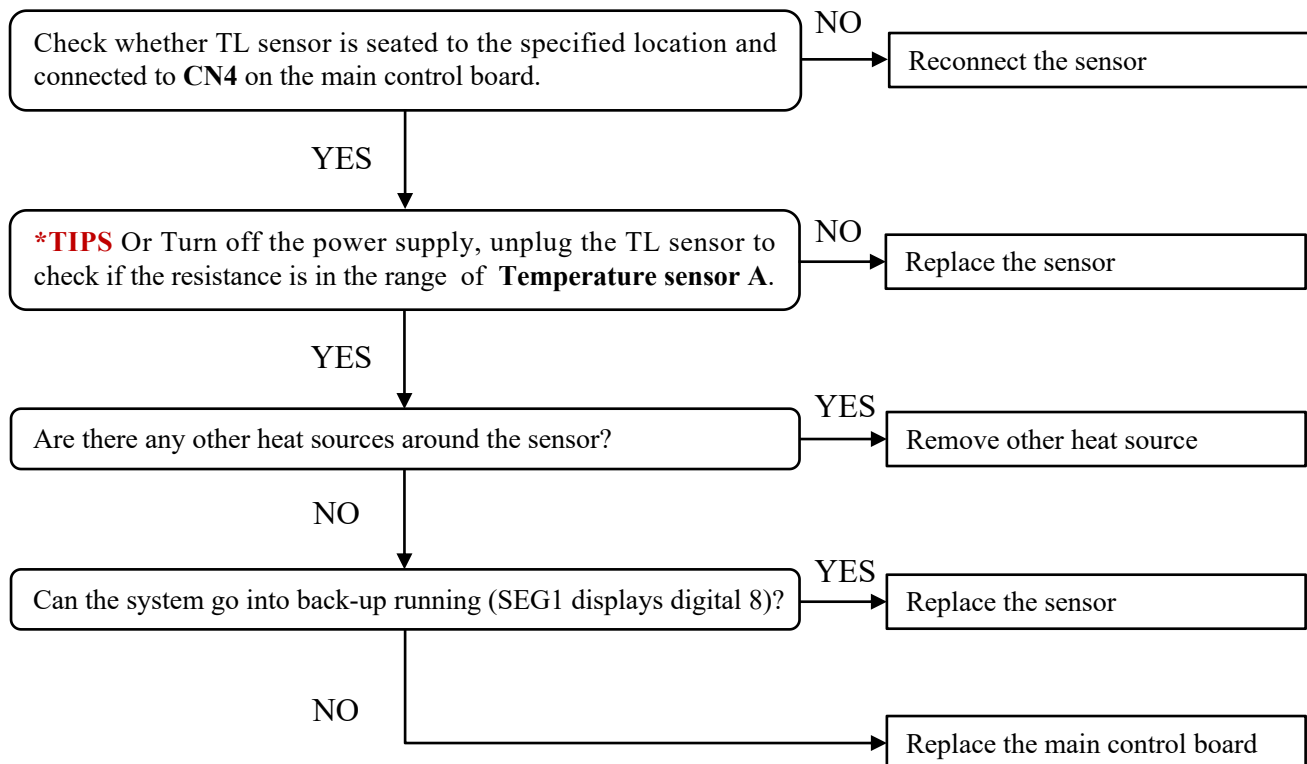

TIPS: Measure the DC voltage of the temperature sensor when outdoor unit powers on.

Display

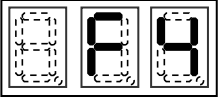

Defrost temperature (TH) sensor fault

1.Error definition:

The defrost temperature (TH) sensor is short circuit or open circuit.

2.Possible causes:

- Damaged main control board
- Loose connection at port on main control board
- Damaged temperature sensor
- There are other heat sources around the sensor

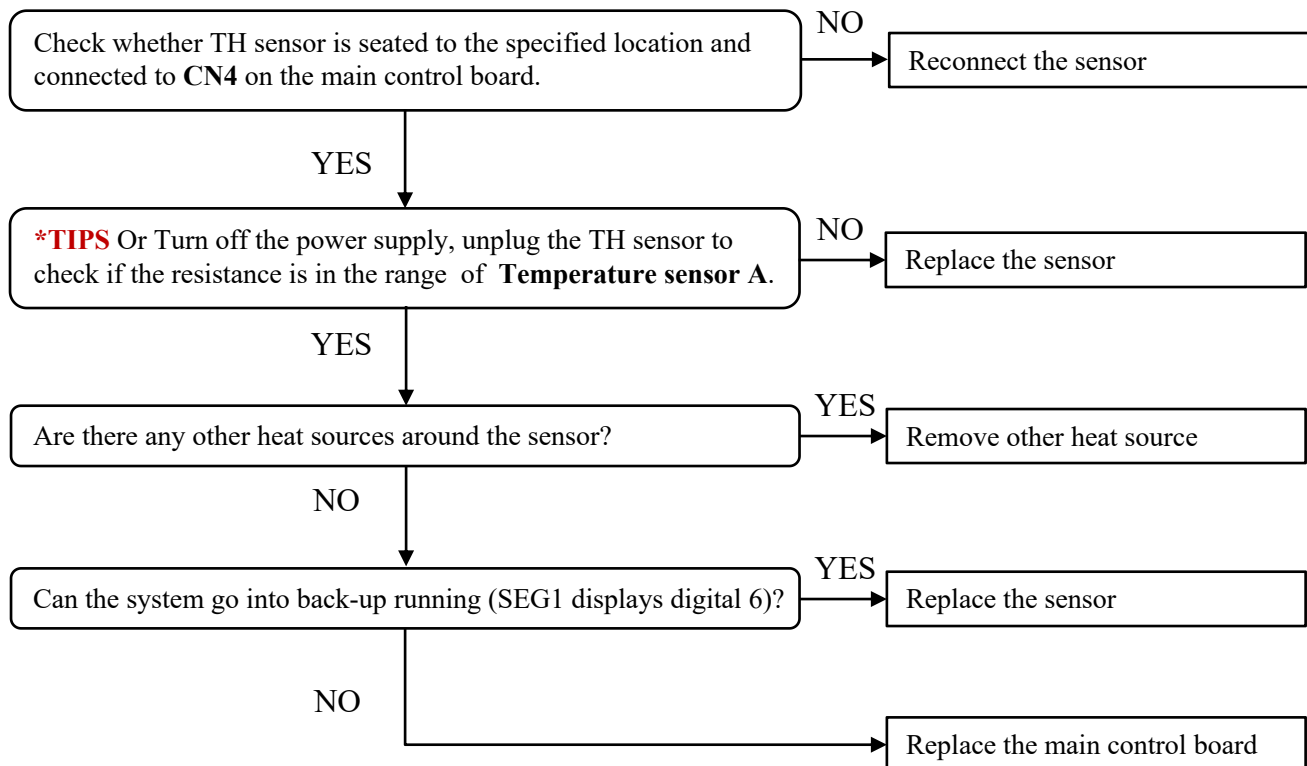

TIPS: Measure the DC voltage of the temperature sensor when outdoor unit powers on.

Display

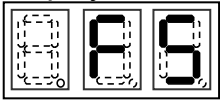

Compressor discharge temperature (TD) sensor fault

1.Error definition:

The discharge temperature (TD) sensor is short circuit or open circuit.

2.Possible causes:

- Damaged main control board
- Loose connection at port on main control board
- Temperature sensor failure
- There are other heat sources around the sensor

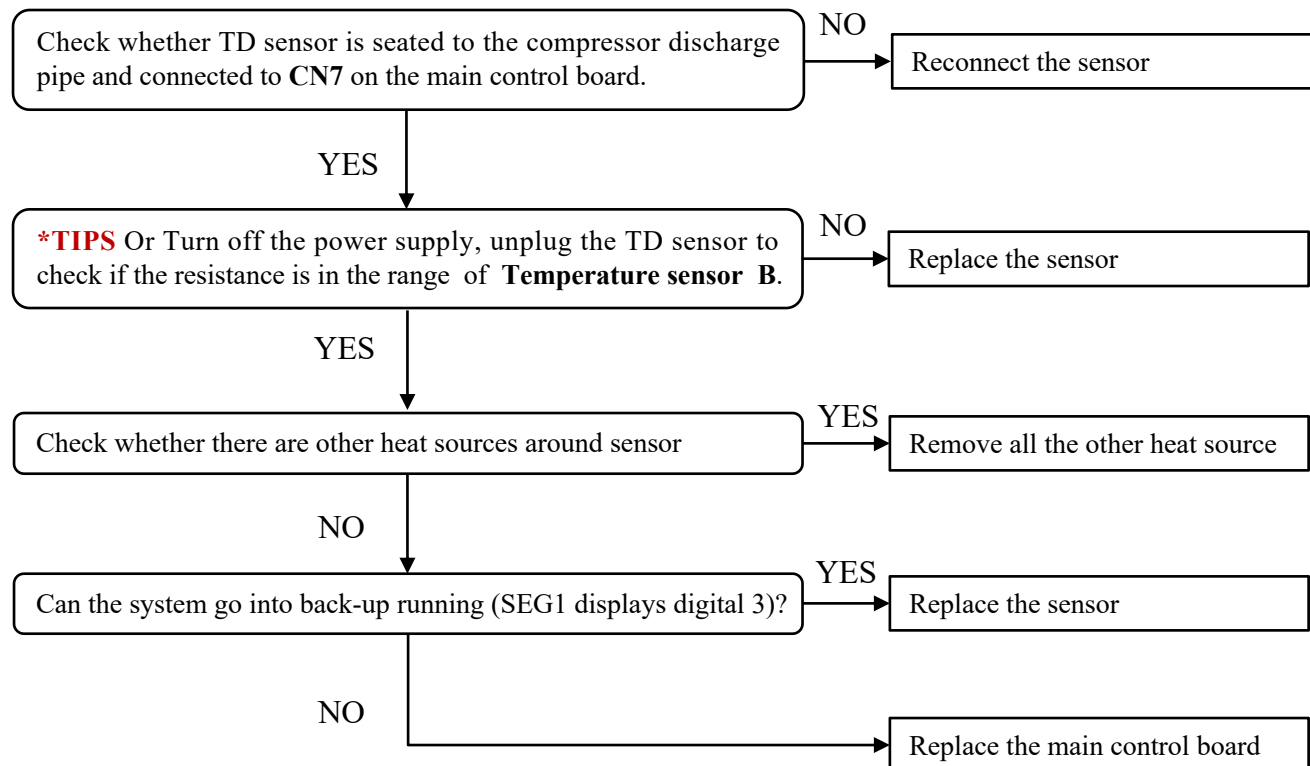

TIPS: Measure the DC voltage of the temperature sensor when outdoor unit powers on.

Display

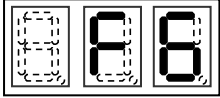

Inverter module temperature (TF) sensor fault

1.Error definition:

The module temperature(TF) sensor is short circuit or open circuit.

2.Possible causes:

- Damaged main control board
- Loose connection at port on main control board
- Temperature sensor failure(**PCB2.0 built-in TF sensor**)
- There are other heat sources around the sensor

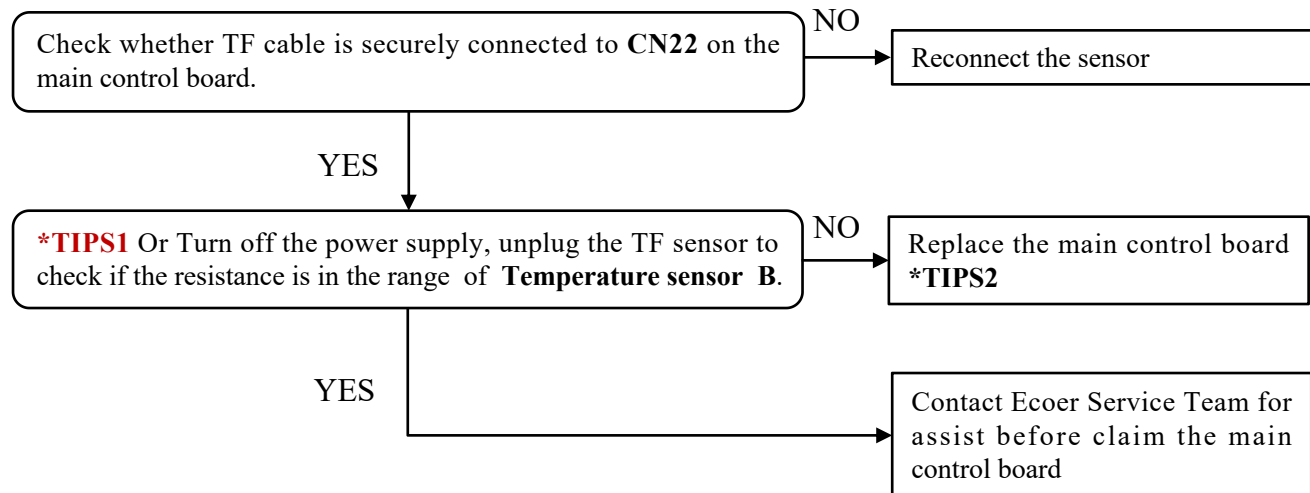

TIPS:

1. Measure the DC voltage of the temperature sensor when outdoor unit powers on.
2. TF sensor has been laid inside the assembly control box with silicon gel contacting the radiator. It's required to replace the main control board in this case.

Display

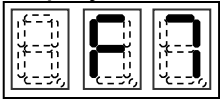

High pressure (HP) sensor fault

1. Error definition and method to check:

The high pressure sensor is open or shorted.

The voltage between CN10 pin(1) and (2) is not in the range 0.59~4.76VDC.

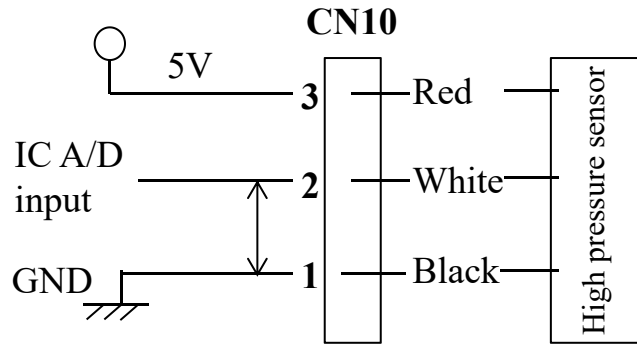

Measure DC voltage within these pins

2. Possible causes:

- Damaged main control board
- Loose connection at port on main control board
- Damaged high pressure sensor
- Too little refrigerant remains in the system

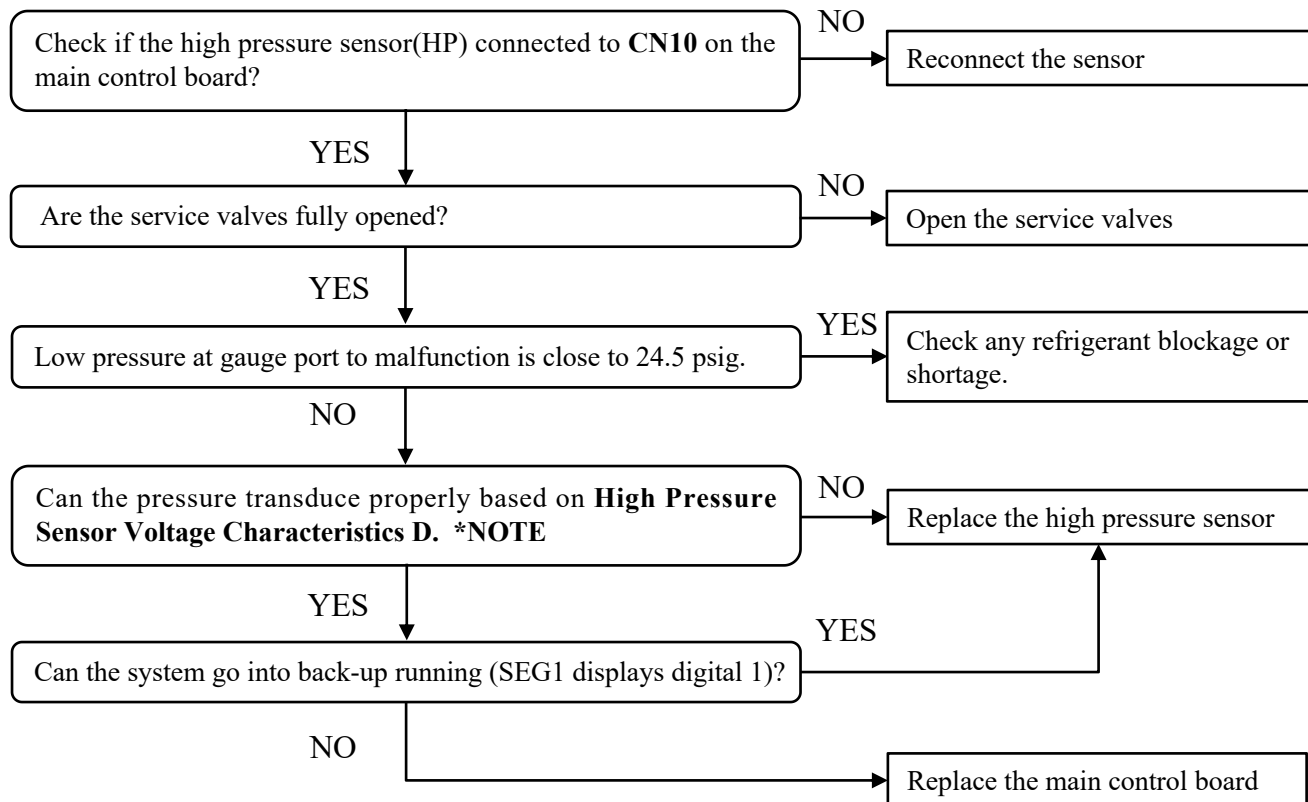

NOTE: Connect a pressure gauge to liquid service valve in cooling mode, gas service valve in heating mode. Compare the value difference between gauged pressure and the transduced one by high pressure sensor (spot check by BS3 button or check the data from ESS Pro App).

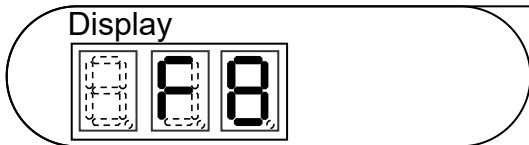

Low pressure (LP) sensor fault

1. Error definition and method to check:

The low pressure sensor is open or shorted.

The voltage between CN9 pin(1) and (2) is not in the range 0.70~4.50VDC.

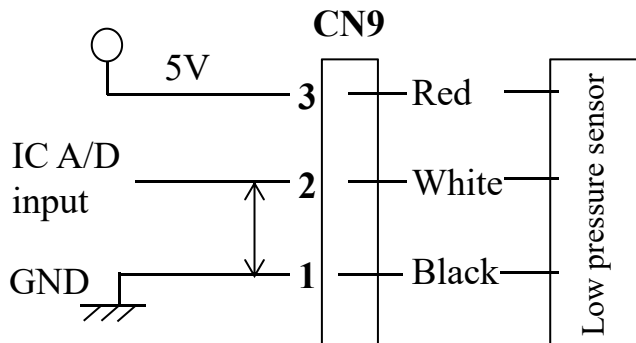

Measure DC voltage within these pins

2. Possible causes:

- Damaged main control board
- Loose connection at port on main control board
- **Incorrect TXV type causes high temperature in heating**
- Damaged low pressure sensor
- Too little refrigerant remains in the system

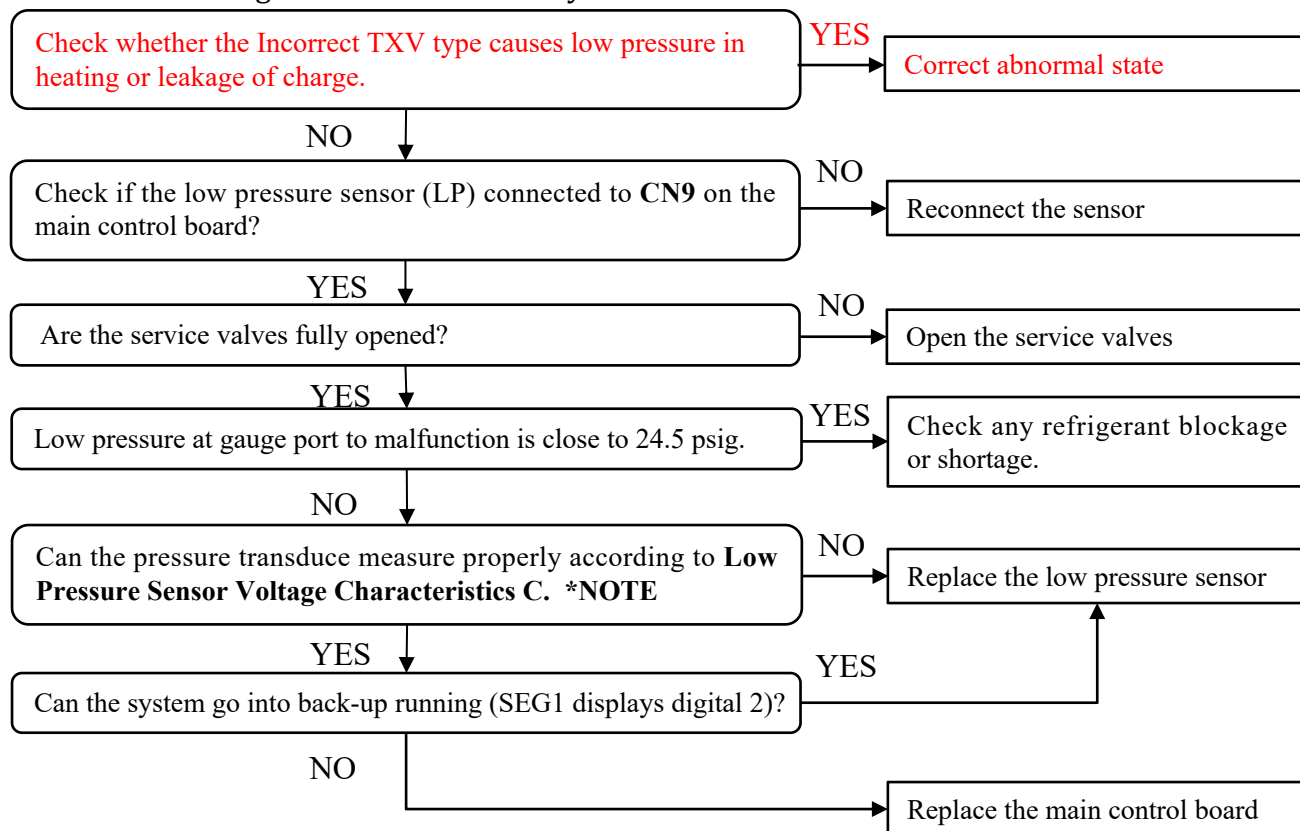

NOTE: Connect a pressure gauge to gauge port, compare the difference between the gauged pressure and the transduced one by low pressure sensor (spot check by BS3 button or check the data from ESS Pro App).

Display

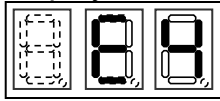

Communication fault between main chip and INV drive chip

1. Error definition and method to check:

Communication fault between the main control chip and inverter chip.

2. Possible causes:

- Loose connection at CN21 terminal
- Damaged main control board

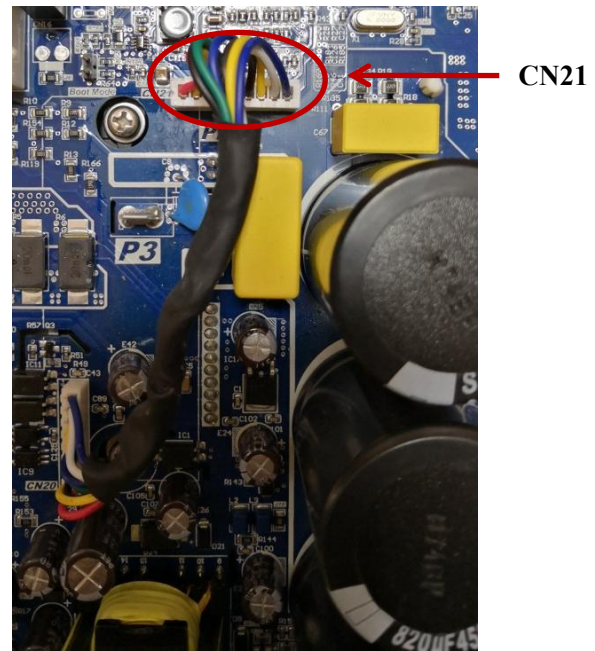
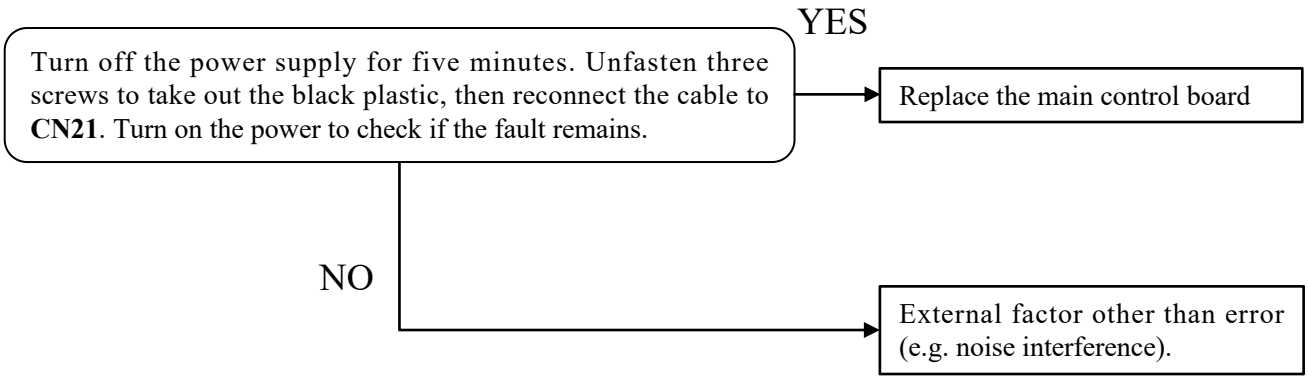

Display

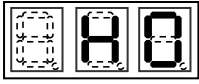

Heavy undercharge limit operation

1.Error definition:

Heavy undercharge when turn to operation.

2.Possible causes:

- Refrigerant leakage
- Refrigerant undercharge
- HP/LP Pressure failure
- Temperature sensor(TH/TL/Ta) failure
- Occasional sensor anomaly

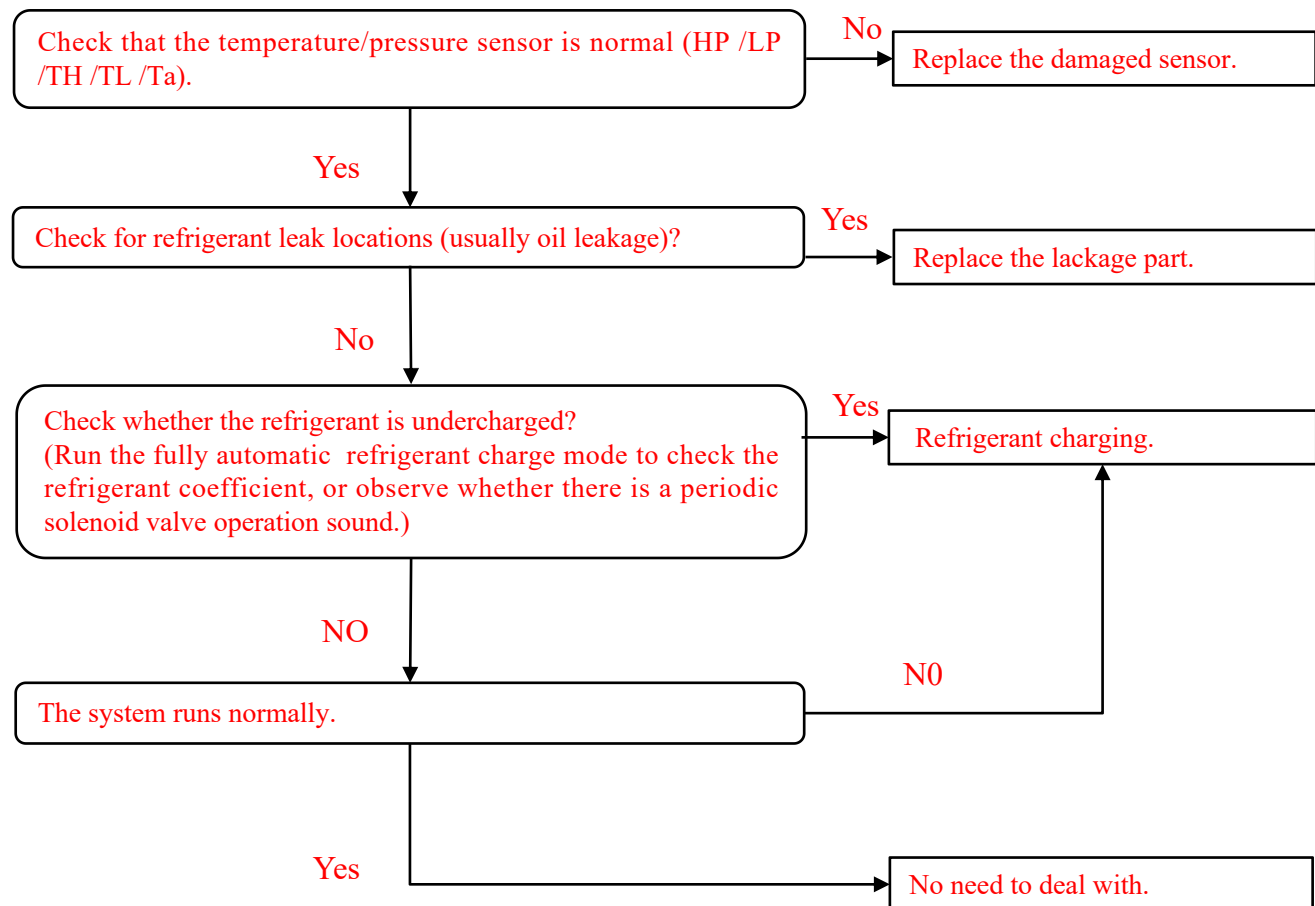

Display

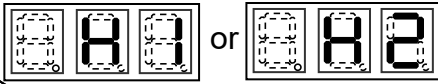

Ambient temperature limit operation

1.Error definition and method to check:

H1: The detected ambient temperature is absolutely prohibited for cooling.

TA < 20°F or ≥ 140°F

H2: The detected ambient temperature is absolutely prohibited for heating.

TA ≥ 86°F or TA < forced heating stop temperature set by n01

2.Possible causes:

- The ambient temperature exceeds the set range of operation.
- The system is running previous mode
- Damaged ambient temperature sensor (TA)
- Damaged main control board.

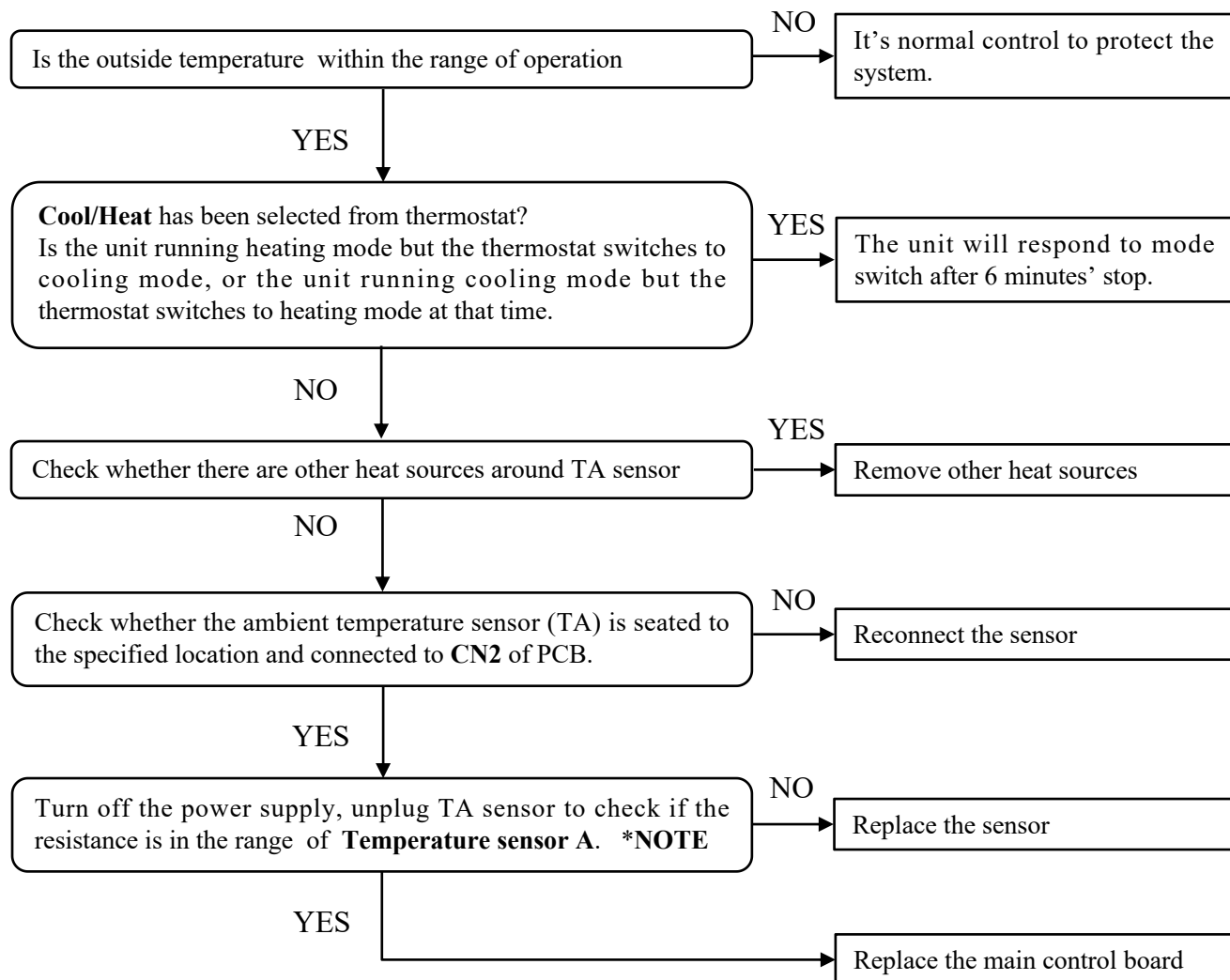

Display

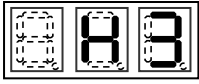

Abnormal switch alarm for reversing valve

1.Error definition:

4-way (reversing) valve switches incompletely after defrost operation or from cooling mode. Report H3 alarm if $TH \geq TL + 10.8^{\circ}F$ and $TH \geq TA + 5.4^{\circ}F$.

2.Possible causes:

- Damaged reversing valve(coil or body)
- Damaged main control board
- Abnormal voltage of power supply
- Temperature sensor(TH) failure
- Reversed location between TH and TL

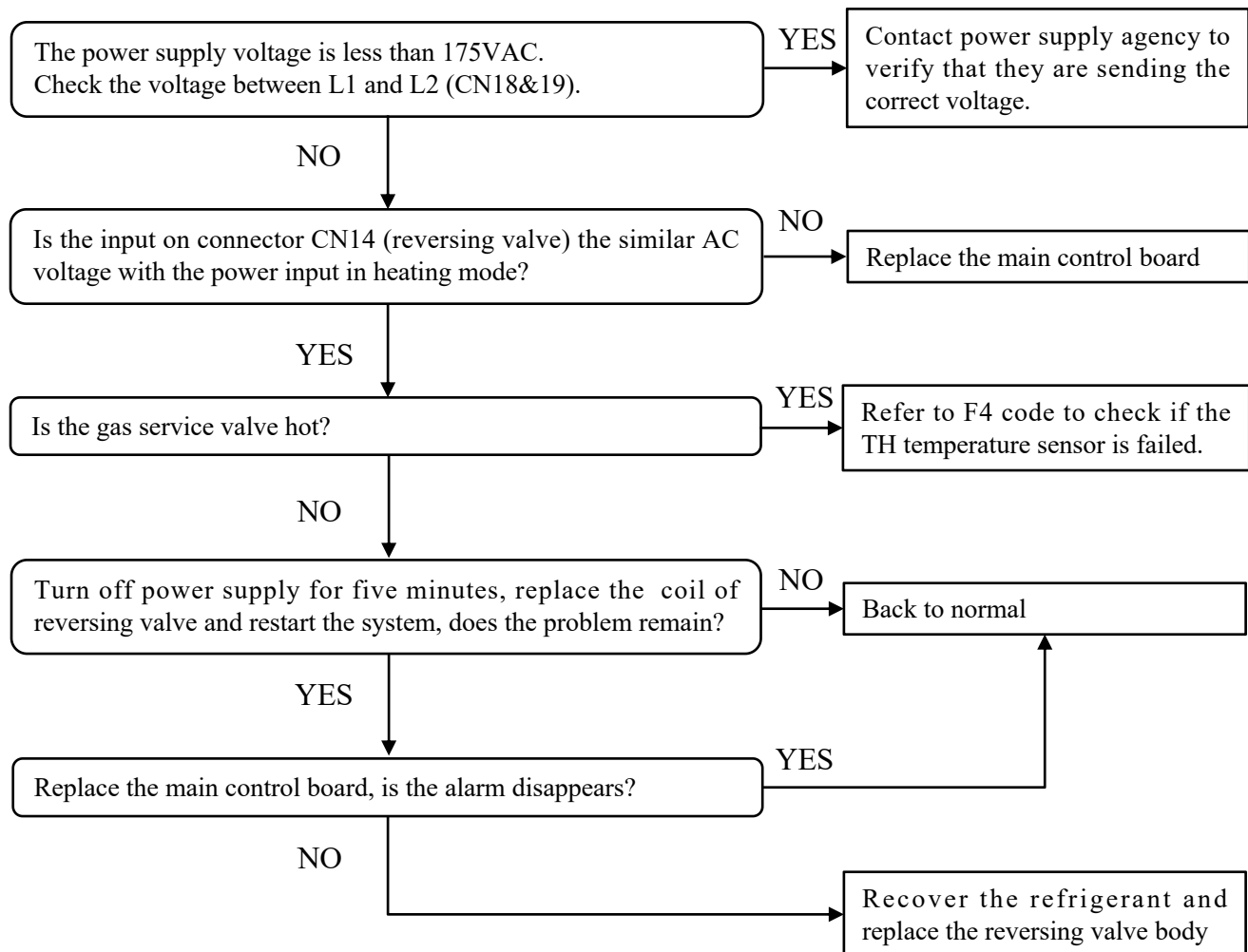

Display

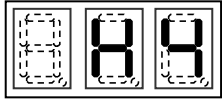

Defrost temperature (TH) sensor is disconnected or damaged

1.Error definition:

The defrost temperature (TH) sensor is short circuit or open circuit.

2.Possible causes:

- Damaged main control board
- The defrost temperature sensor is wrongly seated
- Temperature sensor failure
- There are other heat sources around the sensor

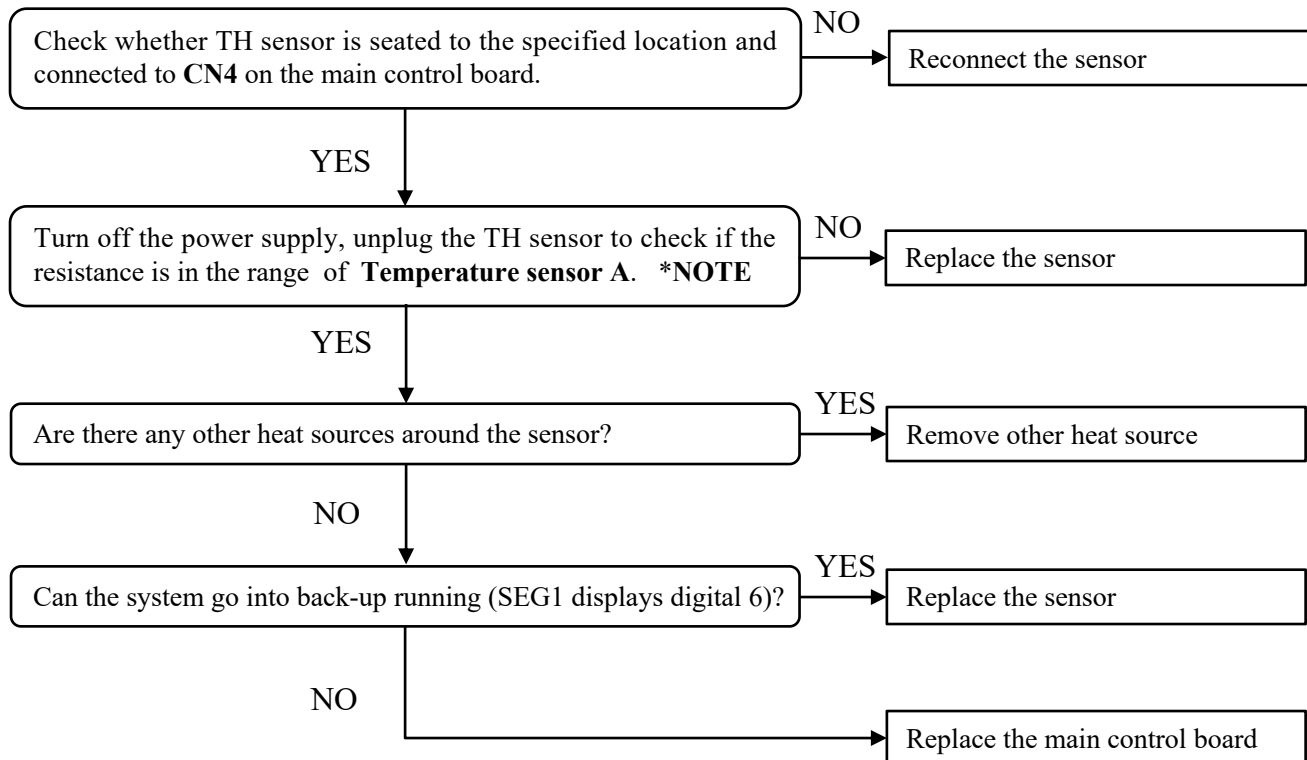

NOTE: Measure the DC voltage of the temperature sensor also works when outdoor unit powers on.

Display

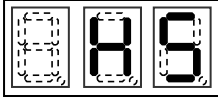
**EEPROM fault****1.Error definition:**

Data cannot be correctly received from the EEPROM to main chip.

EEPROM, a type of memory component, remembers contents even though power off.

2.Possible causes:

- Damaged main control board

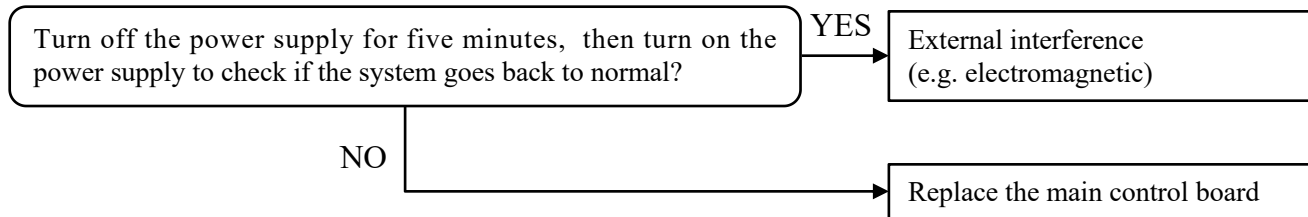

Display

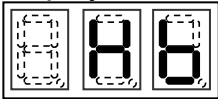
**Low voltage alarm****1.Error definition:**

Power supply voltage is less than 175VAC.

2.Possible causes:

- Abnormal power supply voltage
- Damaged main control board

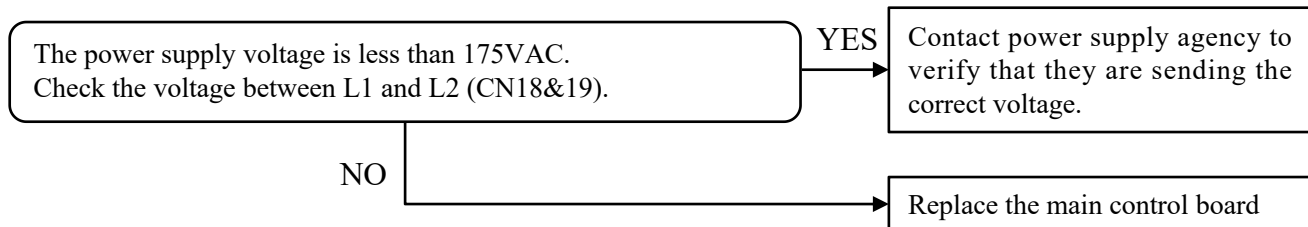

Display

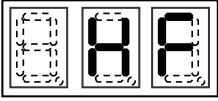

Abnormal function control

1.Error definition:

Cannot exit special control (start-up, oil return or defrost)

2.Possible causes:

- Very poor charge
- The compressor does not work properly
- Abnormal signal input from thermostat

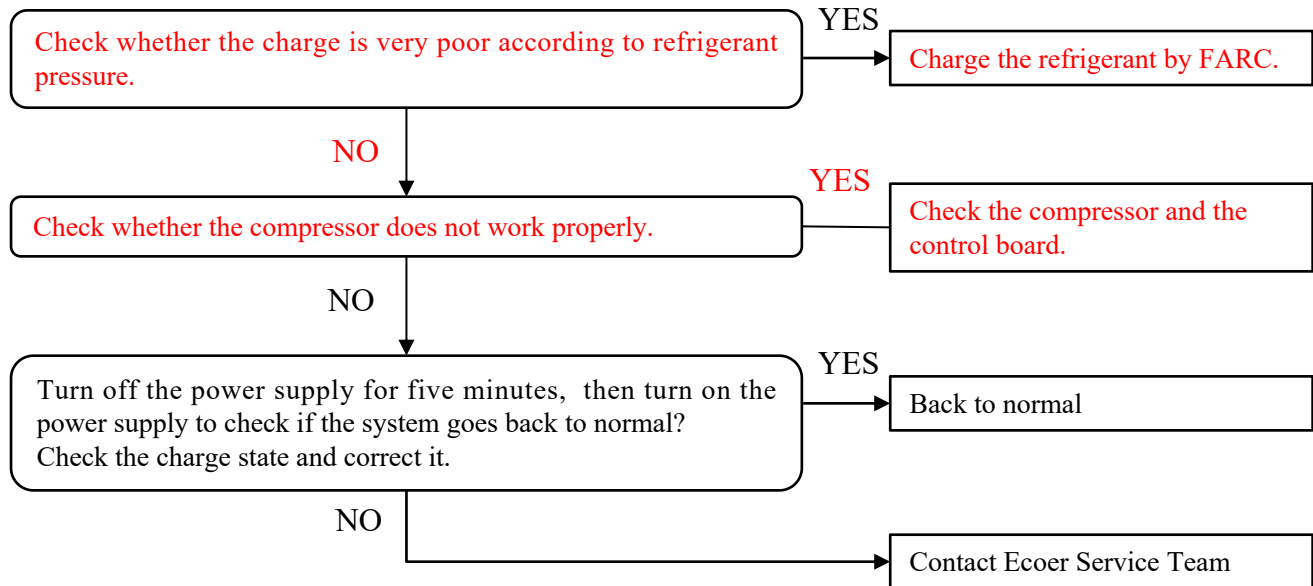

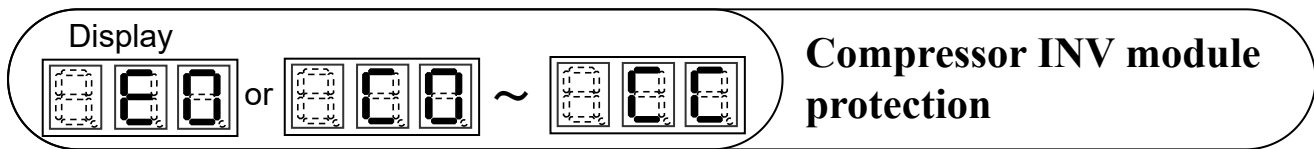

1. Error definition:

Code	LED Display	Definition
C0		Critical over-voltage fault
C1		DC bus over-voltage protection
C2		DC bus under-voltage protection
C3		Over-current protection
C4		Zero speed fault
C7		Compressor speed inconsistent fault
C9		Compressor speed difference between given transient variation and actual operation
CA		AC over-voltage protection
CB		AC under-voltage protection
CC		PFC error

E0: System locks up when C0~CA has occurred three times in 60 minutes.

2. Possible causes:

- Abnormal power supply voltage
- Power supply disconnected (C2/C7/C9 or C2/C3/C7 report at the same time)
- Dirty compressor terminal or damaged compressor
- Damaged main control board
- Micro channel coil has been used for heat pump
- **Compressor terminal or wire is loose.**

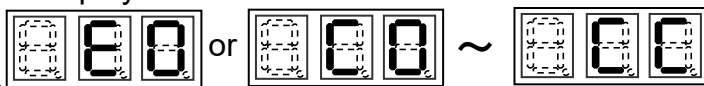
Display  **Compressor INV module protection**

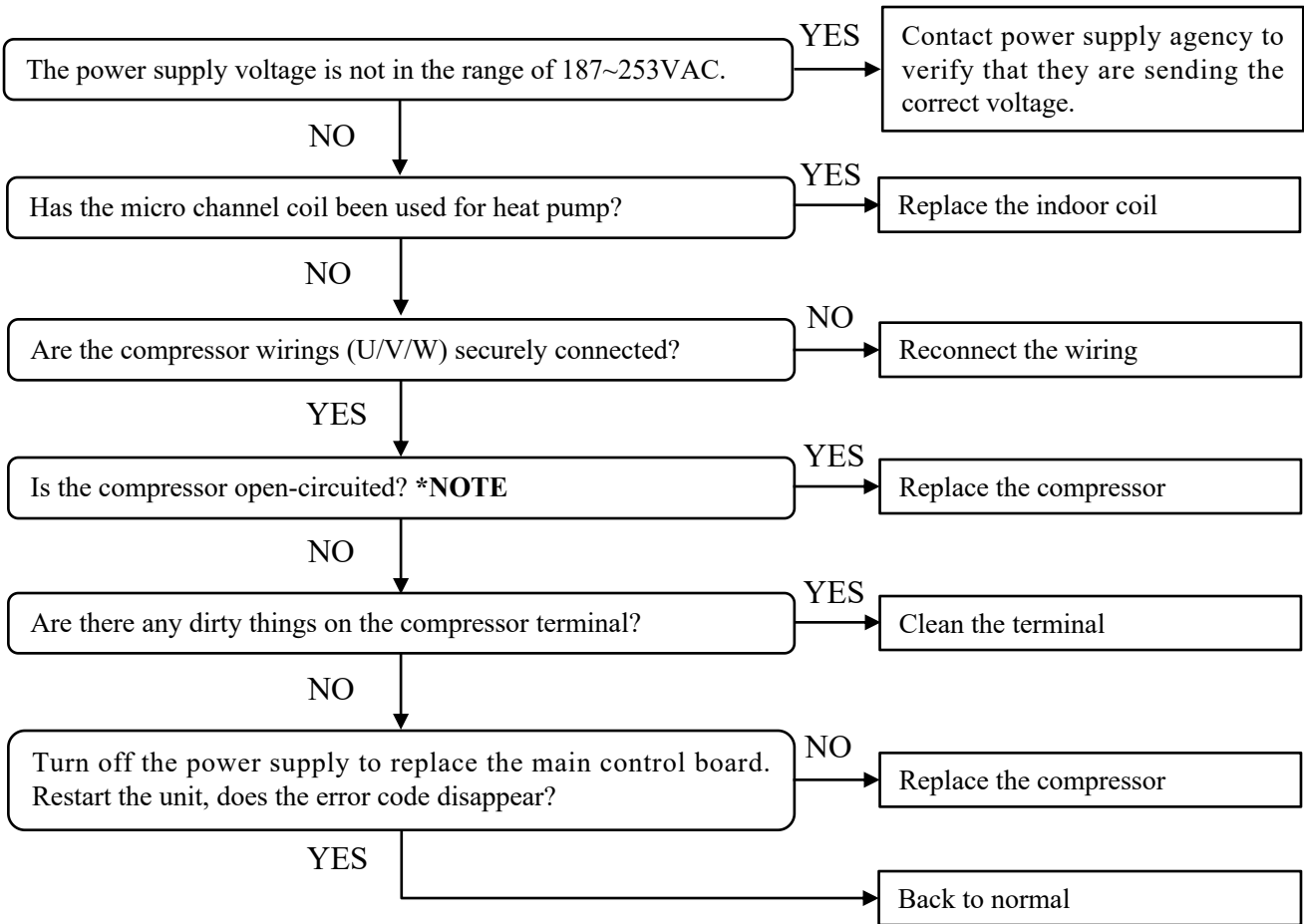

NOTE: Normal resistance for compressor

3-phase resistance (UV, UW, VW) for compressor is less than 5Ω.

The insulation resistance (any phase to Ground) for compressor is greater than 100KΩ.

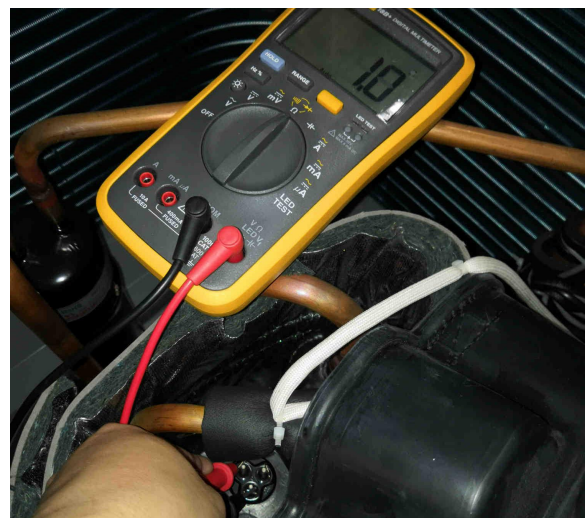

How to diagnose the INV module is damaged or not



Turn off the power supply for five (5) minutes prior to do the diagnosis.

Disconnect the compressor wiring from the main control board.

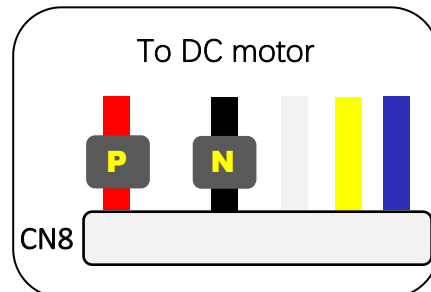

Are the resistances between P (Red wiring in CN8) and U/V/W, N (Black wiring in CN8) and U/V/W over 100KΩ ? i.e.

$R_{P-U} > 100K\Omega$ | $R_{P-V} > 100K\Omega$ | $R_{P-W} > 100K\Omega$
 $R_{N-U} > 100K\Omega$ | $R_{N-V} > 100K\Omega$ | $R_{N-W} > 100K\Omega$

NO

INV module is damaged



YES

Use diode ap to measure the voltage between U/V/W and P (Red wiring in CN8), N (Black wiring in CN8) and U/V/W.

Are the voltages normal?

RED Probe '+' electrode	BLACK Probe '-' electrode	VOLTAGE
U	P	0.4±0.1 VDC
V	P	0.4±0.1 VDC
W	P	0.4±0.1 VDC
N	U	0.4±0.1 VDC
N	V	0.4±0.1 VDC
N	W	0.4±0.1 VDC

NO

INV module is damaged



YES

INV module works properly

4 Parts list

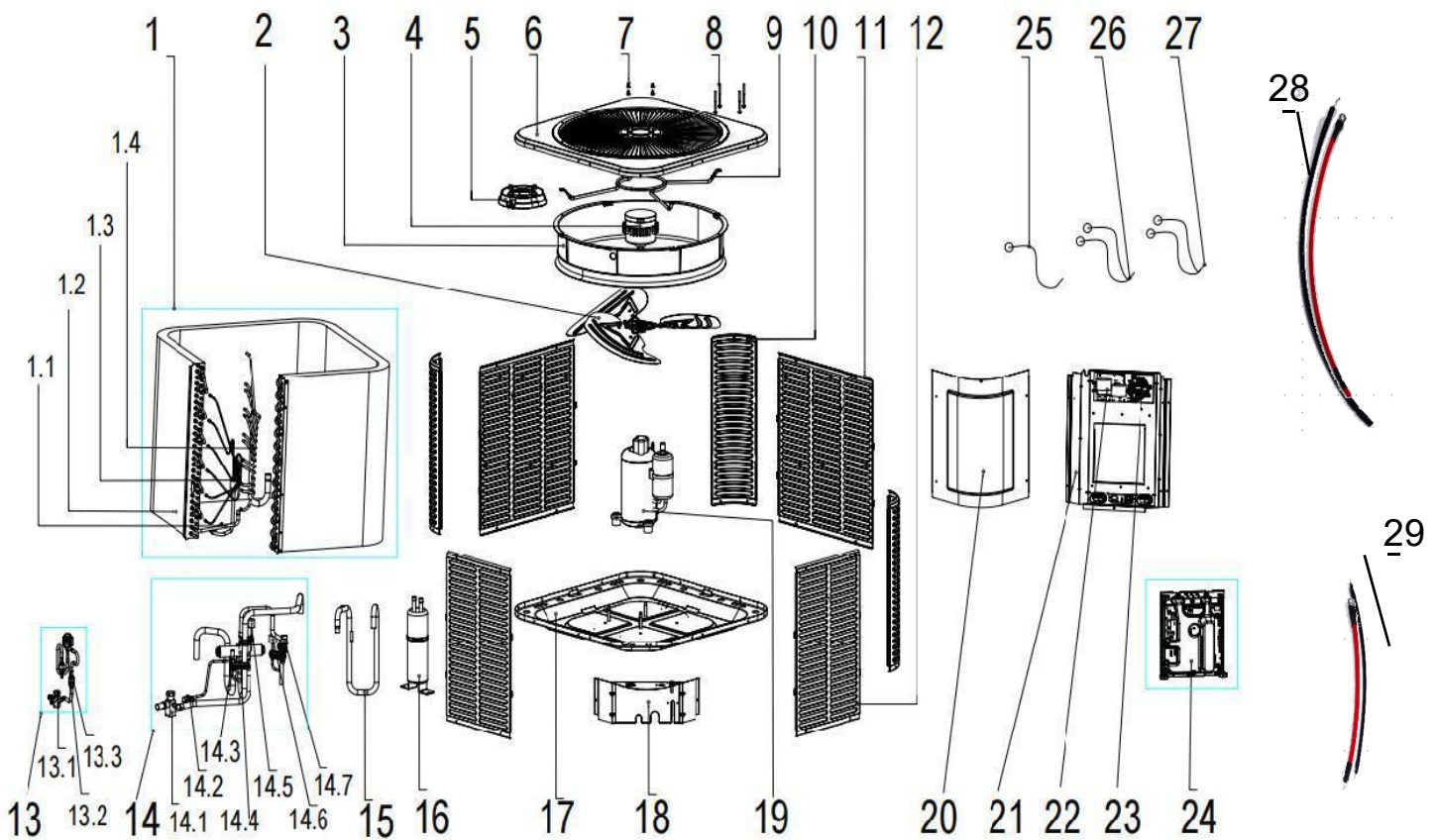

#	Part Name	Quantity	Parts number	
			2436AAA	4860AAA
1	Condenser ass'y	1	E.AC.2312100016	E.AC.2312100022
1.1	Condenser connection pipe ass'y	1	E.AC.2400000102	E.AC.2400000042
1.2	Condenser	1	E.AC.2400000076	E.AC.2400000031
1.3	Condenser outlet pipe ass'y	1	E.AC.2400000091	E.AC.2400000056
1.4	Condenser inlet pipe ass'y	1	E.AC.2400000115	E.AC.2400000043
2	Fan	1	E.AC.2308100008	
3	Guide ring	1	E.AC.2307100001	
4	Brushless DC Motor	1	E.AC.2323100001	
5	Motor installation board ass'y	1	E.AC.230803381	
6	Top cover ass'y	1	E.AC.41207-000036	
7	Cap nut	4	E.AC.2319100015	
8	Electrical installation bolt	4	E.AC.2319100013	

#	Part Name	Quantity	Parts number		Remark
			2436AAA	4860AAA	
9	Roof support frame	1	E.AC.2308100007		
10	Supporting board	3	E.AC.230801590B	E.AC.230801609B	
11	Side board ass'y	2	E.AC.230803142	E.AC.230802064A	
12	Side board ass'y	2	E.AC.230803143	E.AC.230802065A	
13	High-pressure valve ass'y	1	E.AC.2312100019	E.AC.2312100025	
13.1	Liquid block valve	1	E.AC.2312100008		
13.2	Electronic expansion valve (EEV)	1	E.AC.2312100013	E.AC.2312100007	
13.3	EEV solenoid coil	1	E.AC.2309100009		
14	Reversing valve ass'y	1	E.AC.2312100017	E.AC.2312100023	
14.1	Gas block valve	1	E.AC.2312100012	E.AC.2312100004	
14.2	Pipe joint ass'y	1	E.AC.2312100006		
14.3	Solenoid valve	1	E.AC.2312100005		
14.4	Reversing valve	1	E.AC.2312100003 E.AC.2309100008		E.AC.2312100003-valve body E.AC.2309100008-valve coil
14.5	Low pressure sensor	1	E.AC.2309100004		Blue color
14.6	High pressure sensor	1	E.AC.2309100002		Red color
14.7	High pressure switch	1	E.AC.2309100003		
15	Suction pipe ass'y	1	E.AC.2312100018	E.AC.2312100026	
16	Refrigerant accumulator	1	E.AC.2312100010	E.AC.2312100029	
17	Chassis Parts	1	E.AC.41202-000347		
18	Lower side plate	1	E.AC.230803138	E.AC.230803139	
19	Compressor	1	E.AC.2315100002	E.AC.2315100001	
20	Upper cover plate	1	E.AC.41105-000330	E.AC.41105-000331	
21	Electrically controlled mounting board	1	E.AC.41214-001011	E.AC.41214-001012	
22	Noise filter ass'y' (EMI)	1	E.AC.230904101	E.AC.230904102	
23	PFC inductor	1	E.IND.080012	E.IND.080011	
24	Motherboard component	1	E.AC.230904165	E.AC.230904166	
25	Discharge Temp. sensor	1	E.AC.2309100007		TD temperature sensor
26	Pipe Temp. sensor ass'y	1	E.AC.2309100006		TL temperature sensor TH temperature sensor
27	Temp. sensor ass'y	1	E.AC.2309100005		TS temperature sensor TA temperature sensor
28	Power cable assembly (RED+BLACK)	1	E.CAB.000001		
29	Power cable assembly connecting EMI and PCB	1	E.CAB.020003		connecting EMI and PCB CN19-Red color connecting EMI and PCB CN18-Black color

5 Appendix

5.1 Sensor Characteristic

Temperature sensor A* (TS, TH, TA, TL)

Temp. (° C)	Temp. (° F)	Resistance (KΩ)	Voltage (V)
-20	-4	104.86	2.77
-19	-2.2	98.84	2.74
-18	-0.4	93.21	2.72
-17	1.4	87.93	2.69
-16	3.2	82.98	2.66
-15	5	78.33	2.63
-14	6.8	73.97	2.6
-13	8.6	69.88	2.57
-12	10.4	66.03	2.53
-11	12.2	62.42	2.5
-10	14	59.02	2.46
-9	15.8	55.82	2.43
-8	17.6	52.81	2.39
-7	19.4	49.98	2.36
-6	21.2	47.32	2.32
-5	23	44.81	2.28
-4	24.8	42.45	2.24
-3	26.6	40.22	2.2
-2	28.4	38.12	2.16
-1	30.2	36.15	2.12
0	32	34.28	2.08
1	33.8	32.52	2.04
2	35.6	30.86	2
3	37.4	29.29	1.96
4	39.2	27.81	1.92
5	41	26.42	1.88
6	42.8	25.10	1.84
7	44.6	23.85	1.79
8	46.4	22.67	1.75
9	48.2	21.56	1.71
10	50	20.50	1.67
11	51.8	19.51	1.63
12	53.6	18.56	1.59
13	55.4	17.67	1.55
14	57.2	16.83	1.51
15	59	16.03	1.47
16	60.8	15.27	1.43
17	62.6	14.55	1.39
18	64.4	13.87	1.35
19	66.2	13.23	1.31
20	68	12.62	1.28
21	69.8	12.04	1.24

Temp. (° C)	Temp. (° F)	Resistance (KΩ)	Voltage (V)
22	71.6	11.49	1.2
23	73.4	10.97	1.17
24	75.2	10.47	1.13
25	77	10.00	1.1
26	78.8	9.55	1.07
27	80.6	9.13	1.03
28	82.4	8.73	1
29	84.2	8.35	0.97
30	86	7.98	0.94
31	87.8	7.64	0.91
32	89.6	7.31	0.88
33	91.4	6.99	0.86
34	93.2	6.70	0.83
35	95	6.41	0.8
36	96.8	6.14	0.78
37	98.6	5.89	0.75
38	100.4	5.64	0.73
39	102.2	5.41	0.7
40	104	5.19	0.68
41	105.8	4.97	0.66
42	107.6	4.77	0.64
43	109.4	4.58	0.61
44	111.2	4.39	0.59
45	113	4.22	0.57
46	114.8	4.05	0.56
47	116.6	3.89	0.54
48	118.4	3.74	0.52
49	120.2	3.59	0.5
50	122	3.45	0.49
51	123.8	3.32	0.47
52	125.6	3.19	0.45
53	127.4	3.07	0.44
54	129.2	2.95	0.42
55	131	2.84	0.41
56	132.8	2.73	0.4
57	134.6	2.63	0.38
58	136.4	2.53	0.37
59	138.2	2.44	0.36
60	140	2.35	0.35
61	141.8	2.26	0.34
62	143.6	2.18	0.32
63	145.4	2.10	0.31

Temp. (° C)	Temp. (° F)	Resistance (KΩ)	Voltage (V)
64	147.2	2.02	0.3
65	149	1.95	0.29
66	150.8	1.88	0.28
67	152.6	1.81	0.27
68	154.4	1.75	0.26
69	156.2	1.68	0.26
70	158	1.63	0.25
71	159.8	1.57	0.24
72	161.6	1.51	0.23
73	163.4	1.46	0.22
74	165.2	1.41	0.22
75	167	1.36	0.21
76	168.8	1.31	0.2
77	170.6	1.27	0.2
78	172.4	1.23	0.19
79	174.2	1.19	0.18
80	176	1.15	0.18
81	177.8	1.11	0.17
82	179.6	1.07	0.17
83	181.4	1.03	0.16
84	183.2	1.00	0.16
85	185	0.97	0.15
86	186.8	0.94	0.15
87	188.6	0.91	0.14
88	190.4	0.88	0.14
89	192.2	0.85	0.13
90	194	0.82	0.13
91	195.8	0.80	0.13
92	197.6	0.77	0.12
93	199.4	0.75	0.12
94	201.2	0.72	0.12
95	203	0.70	0.11
96	204.8	0.68	0.11
97	206.6	0.66	0.11
98	208.4	0.64	0.1
99	210.2	0.62	0.1
100	212	0.60	0.1
101	213.8	0.59	0.09
102	215.6	0.57	0.09
103	217.4	0.55	0.09
104	219.2	0.54	0.09
105	221	0.52	0.08

Remarks:

Above table shows the average resistance corresponding to the temperature.

Resistance tolerance is $\pm 6\%$.

Temperature sensor B* (TF, TD)

Temp. (° C)	Temp. (°F)	Resistance (K Ω)	Voltage (V)
-20	-4	517.84	3.03
-19	-2.2	489.93	3.01
-18	-0.4	463.65	3
-17	1.4	438.89	2.98
-16	3.2	415.57	2.96
-15	5	393.59	2.95
-14	6.8	372.87	2.93
-13	8.6	353.34	2.91
-12	10.4	334.92	2.89
-11	12.2	317.55	2.87
-10	14	301.16	2.85
-9	15.8	285.70	2.83
-8	17.6	271.10	2.81
-7	19.4	257.33	2.79
-6	21.2	244.32	2.77
-5	23	232.03	2.74
-4	24.8	220.42	2.72
-3	26.6	209.45	2.7
-2	28.4	199.08	2.67
-1	30.2	189.27	2.64
0	32	180.00	2.62
1	33.8	171.23	2.59
2	35.6	162.93	2.56
3	37.4	155.07	2.53
4	39.2	147.63	2.5
5	41	140.59	2.47
6	42.8	133.92	2.44
7	44.6	127.60	2.41
8	46.4	121.60	2.38
9	48.2	115.93	2.35
10	50	110.54	2.32
11	51.8	105.43	2.28
12	53.6	100.59	2.25
13	55.4	95.99	2.22
14	57.2	91.62	2.18
15	59	87.48	2.15
16	60.8	83.54	2.11
17	62.6	79.80	2.08
18	64.4	76.25	2.04
19	66.2	72.87	2.01
20	68	69.66	1.97
21	69.8	66.61	1.93
22	71.6	63.70	1.9
23	73.4	60.94	1.86
24	75.2	58.31	1.83
25	77	55.81	1.79
26	78.8	53.42	1.76
27	80.6	51.15	1.72
28	82.4	48.99	1.68
29	84.2	46.93	1.65
30	86	44.97	1.61

Temp. (° C)	Temp. (°F)	Resistance (K Ω)	Voltage (V)
31	87.8	43.10	1.58
32	89.6	41.31	1.54
33	91.4	39.61	1.51
34	93.2	37.99	1.48
35	95	36.44	1.44
36	96.8	34.96	1.41
37	98.6	33.55	1.37
38	100.4	32.21	1.34
39	102.2	30.92	1.31
40	104	29.69	1.28
41	105.8	28.52	1.25
42	107.6	27.40	1.22
43	109.4	26.32	1.18
44	111.2	25.30	1.15
45	113	24.32	1.13
46	114.8	23.38	1.1
47	116.6	22.49	1.07
48	118.4	21.63	1.04
49	120.2	20.81	1.01
50	122	20.02	0.99
51	123.8	19.27	0.96
52	125.6	18.55	0.93
53	127.4	17.86	0.91
54	129.2	17.20	0.88
55	131	16.57	0.86
56	132.8	15.96	0.84
57	134.6	15.38	0.81
58	136.4	14.82	0.79
59	138.2	14.29	0.77
60	140	13.77	0.75
61	141.8	13.28	0.73
62	143.6	12.81	0.71
63	145.4	12.36	0.69
64	147.2	11.92	0.67
65	149	11.51	0.65
66	150.8	11.11	0.63
67	152.6	10.72	0.61
68	154.4	10.35	0.6
69	156.2	10.00	0.58
70	158	9.66	0.56
71	159.8	9.33	0.55
72	161.6	9.01	0.53
73	163.4	8.71	0.52
74	165.2	8.42	0.5
75	167	8.14	0.49
76	168.8	7.87	0.47
77	170.6	7.61	0.46
77	170.6	7.36	0.45
78	172.4	7.12	0.43
79	174.2	6.89	0.42
80	176	6.86	0.42

Temp. (° C)	Temp. (°F)	Resistance (K Ω)	Voltage (V)
81	177.8	6.67	0.41
82	179.6	6.46	0.4
83	181.4	6.25	0.39
84	183.2	6.05	0.38
85	185	5.86	0.37
86	186.8	5.68	0.36
87	188.6	5.50	0.35
88	190.4	5.33	0.34
89	192.2	5.16	0.33
90	194	5.00	0.32
91	195.8	4.85	0.31
92	197.6	4.70	0.3
93	199.4	4.55	0.29
94	201.2	4.42	0.28
95	203	4.28	0.28
96	204.8	4.15	0.27
97	206.6	4.03	0.26
98	208.4	3.91	0.25
99	210.2	3.79	0.25
100	212	3.68	0.24
101	213.8	3.57	0.23
102	215.6	3.46	0.23
103	217.4	3.36	0.22
104	219.2	3.26	0.21
105	221	3.17	0.21
106	222.8	3.09	0.2
107	224.6	3.00	0.2
108	226.4	2.92	0.19
109	228.2	2.84	0.19
110	230	2.76	0.18
111	231.8	2.68	0.18
112	233.6	2.60	0.17
113	235.4	2.53	0.17
114	237.2	2.46	0.16
115	239	2.39	0.16
116	240.8	2.33	0.16
117	242.6	2.26	0.15
118	244.4	2.20	0.15
119	246.2	2.14	0.14
120	248	2.08	0.14
121	249.8	2.03	0.14
122	251.6	1.97	0.13
123	253.4	1.92	0.13
124	255.2	1.87	0.13
125	257	1.82	0.12
126	258.8	1.77	0.12
127	260.6	1.72	0.12
128	262.4	1.68	0.11
129	264.2	1.63	0.11
130	266	1.59	0.11

Remarks:

Above table shows the average resistance corresponding to the temperature.

Resistance tolerance is $\pm 12\%$.

Low Pressure Sensor Voltage Characteristics C*

Low pressure (MPa)	Low pressure (psig)	Resistance (K Ω)	Output voltage (V)
0.10	14.5	49.51	0.70
0.11	16	47.91	0.72
0.12	17.4	46.40	0.74
0.13	18.9	44.97	0.76
0.14	20.3	43.61	0.78
0.15	21.8	42.32	0.80
0.16	23.2	41.09	0.82
0.17	24.7	39.92	0.84
0.18	26.1	38.80	0.86
0.19	27.6	37.74	0.88
0.21	30.5	35.74	0.92
0.22	31.9	34.81	0.94
0.23	33.4	33.92	0.96
0.24	34.8	33.06	0.98
0.26	37.7	31.45	1.02
0.27	39.2	30.69	1.04
0.29	42.1	29.25	1.08
0.30	43.5	28.58	1.10
0.32	46.4	27.29	1.14
0.33	47.9	26.68	1.16
0.35	50.8	25.52	1.20
0.37	53.7	24.44	1.24
0.38	55.1	23.92	1.26
0.40	58	22.94	1.30
0.42	60.9	22.01	1.34
0.44	63.8	21.14	1.38
0.46	66.7	20.32	1.42
0.48	69.6	19.54	1.46
0.50	72.5	18.81	1.50
0.52	75.4	18.11	1.54
0.54	78.3	17.45	1.58
0.56	81.2	16.82	1.62
0.58	84.1	16.22	1.66
0.61	88.5	15.37	1.72
0.63	91.4	14.84	1.76
0.65	94.3	14.33	1.80

Low pressure (MPa)	Low pressure (psig)	Resistance (K Ω)	Output voltage (V)
0.68	98.6	13.61	1.86
0.70	102	13.15	1.90
0.73	106	12.50	1.96
0.76	110	11.89	2.02
0.78	113	11.50	2.06
0.81	117	10.95	2.12
0.84	122	10.43	2.18
0.87	126	9.93	2.24
0.90	131	9.46	2.30
0.93	135	9.02	2.36
0.96	139	8.59	2.42
0.99	144	8.19	2.48
1.02	148	7.81	2.54
1.06	154	7.32	2.62
1.09	158	6.98	2.68
1.13	164	6.54	2.76
1.16	168	6.23	2.82
1.20	174	5.84	2.90
1.24	180	5.46	2.98
1.27	184	5.20	3.04
1.31	190	4.86	3.12
1.35	196	4.53	3.20
1.39	202	4.23	3.28
1.43	207	3.93	3.36
1.48	215	3.59	3.46
1.52	220	3.32	3.54
1.56	226	3.07	3.62
1.61	233	2.77	3.72
1.65	239	2.55	3.80
1.70	247	2.27	3.90
1.75	254	2.02	4.00
1.80	261	1.77	4.10
1.85	268	1.54	4.20
1.90	276	1.31	4.30
1.95	283	1.10	4.40
2.00	290	0.90	4.50

High Pressure Sensor Voltage Characteristics D*

High pressure (MPa)	High pressure (psig)	Resistance (K Ω)	Output voltage (V)
0.1	14.5	60.60	0.59
0.2	29	51.74	0.67
0.3	43.5	44.90	0.76
0.4	58	39.47	0.85
0.5	72.5	35.05	0.93
0.6	87	31.38	1.02
0.7	101.5	28.29	1.11
0.8	116	25.64	1.20
0.9	130.5	23.36	1.28
1.0	145	21.36	1.37
1.1	159.5	19.61	1.46
1.2	174	18.05	1.54
1.3	188.5	16.66	1.63
1.4	203	15.41	1.72
1.5	217.5	14.27	1.80
1.6	232	13.25	1.89
1.7	246.5	12.31	1.98
1.8	261	11.45	2.07
1.9	275.5	10.66	2.15
2.0	290	9.94	2.24
2.1	304.5	9.26	2.33
2.2	319	8.64	2.41
2.3	333.5	8.06	2.50
2.4	348	7.52	2.59
2.5	362.5	7.01	2.67
2.6	377	6.54	2.76
2.7	391.5	6.09	2.85
2.8	406	5.67	2.93
2.9	420.5	5.28	3.02
3.0	435	4.90	3.11

High pressure (MPa)	High pressure (psig)	Resistance (K Ω)	Output voltage (V)
3.1	449.5	4.55	3.20
3.2	464	4.22	3.28
3.3	478.5	3.90	3.37
3.4	493	3.60	3.46
3.5	507.5	3.31	3.54
3.6	522	3.04	3.63
3.7	536.5	2.78	3.72
3.8	551	2.53	3.80
3.9	565.5	2.30	3.89
4.0	580	2.07	3.98
4.1	594.5	1.85	4.07
4.2	609	1.65	4.15
4.3	623.5	1.45	4.24
4.4	638	1.26	4.33
4.5	652.5	1.07	4.41
4.6	667	0.90	4.50
4.7	681.5	0.73	4.59
4.8	696	0.56	4.67
4.9	710.5	0.40	4.76

5.2 Wiring Diagram

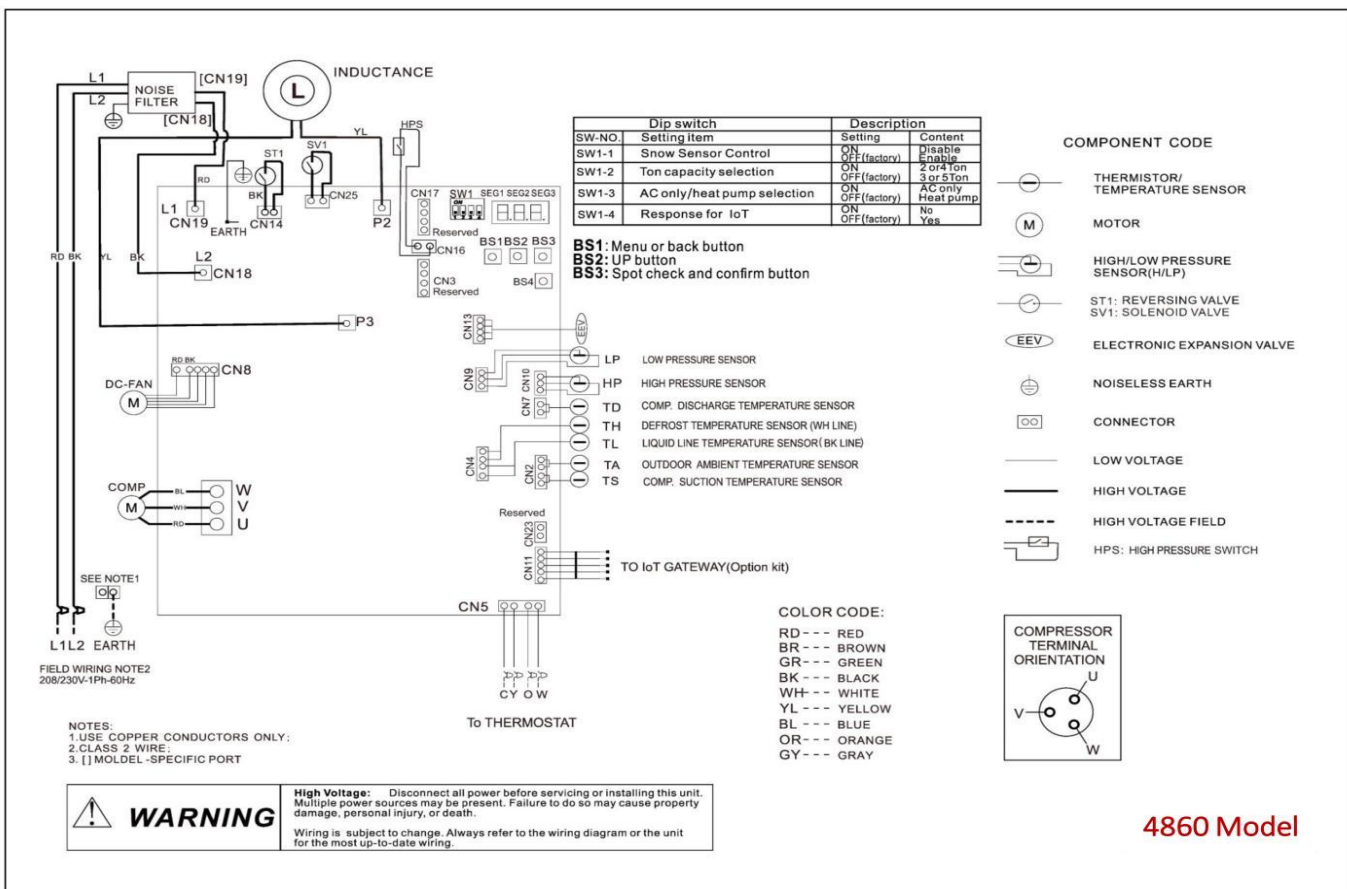
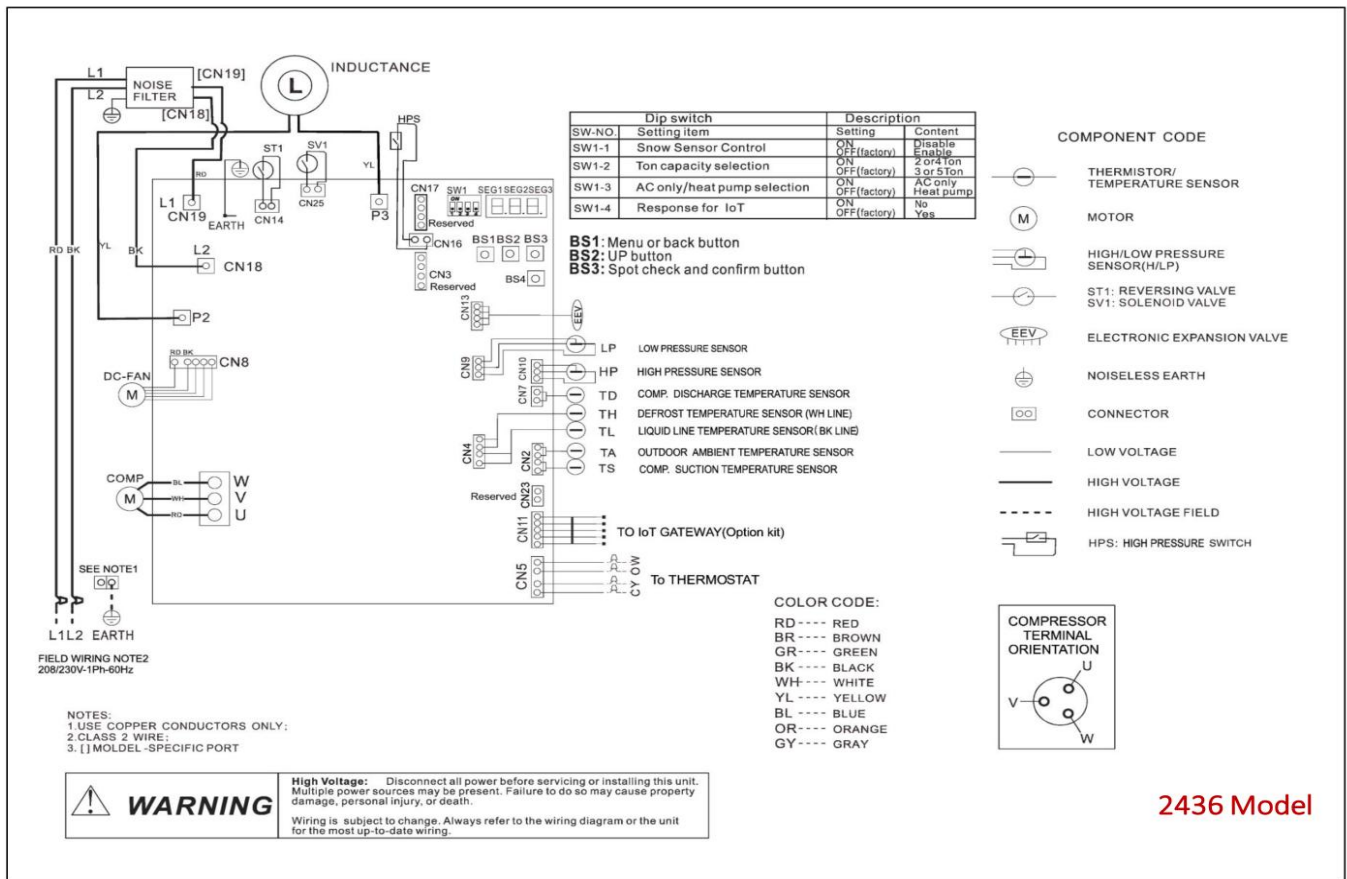

©2022 ECOER INC.

43671 Trade Center Place, Suite 100
Dulles, VA 20166

Tel: 703-348-2538

www.ecoer.com