



# ESi Decades Extreme Refrigerant Charge

- 1. How to enter AUTO charge mode----- 2
- 2. Charging by refrigerant coefficient----- 3
- 3. Charging by weigh-in method----- 4
- TIPS:**How to adjust indoor TXV opening----- 5



# 1. How to enter AUTO charge mode?

Turn on the system, **set 5° F lower than indoor temperature in cooling mode** at thermostat to complete this AUTO charge mode.

Charging method	Outdoor Ambient Temperature	System operation mode when charging
Auto charge mode by refrigerant coefficient	50° F < T < 120° F	Cooling only
Sub-cooling		
Weigh-in	-3° F < T < 122° F	-

**Press and hold BS4 for five (5) seconds** until **SEG1 displays blinking 7**, Then wait for 1 minute to enter AUTO charge mode.

**NOTE:** Start-up control is enforced to complete prior to activate this AUTO charge mode. It may take 4 to 10 minutes to exit start-up control procedure and fix the compressor speed (RPS) as the following table.



**EODA18H-2436**



**EODA18H-4860**

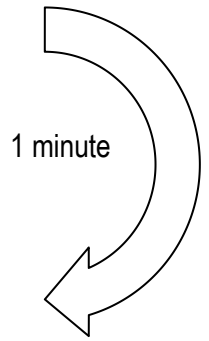

Capacity <sup>*1</sup>	Compressor speed (RPS)	
	Cooling	Heating
2Ton	56	66
3Ton	76	80
4Ton	56	58
5Ton	66	70

**Remarks:**

1. Select the required capacity by dip the 2<sup>nd</sup> switch of SW1 on main control board (MCB).
2. Show low pressure on 7 segment display (LED).

## 2. Charging by refrigerant coefficient

Apply charging and refrigerant adjustment in **cooling mode**.

If outdoor ambient temperature is below 50° F, use weigh-in charge method only.



**Refrigerant coefficient** is used to evaluate the refrigerant level in the ecoer systems.

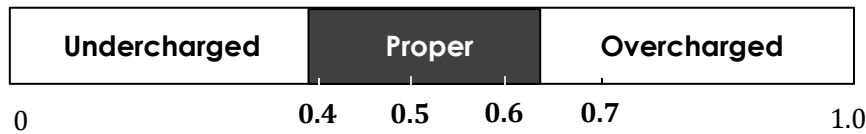

- I. Run the system for 15 to 20 minutes and check the coefficient number (here short for “X”,  $0 < X < 1$ ) from the LED display. A perfect charging should be displayed 0.5. **If the LED displays “--” for more than 20 minutes, stop charging and adjust the TXV opening to ensure required compressor suction superheat (SH).**
- II. If  $X > 0.6$ , **remove som refrigerant**; or  $X < 0.4$ , **add more refrigerant**. Then wait for 5 minutes to allow system pressure balanced. Check the new coefficient number to make sure you get 0.5. (0.4 to 0.6 is acceptable if  $7^{\circ}F \leq SH \leq 20^{\circ}F$ .)

**Note:** Maintain a minimum operation of 5 minutes after every refrigerant charge or TXV opening adjustment. Technically, gauges are not required in this charging method.

**Ecoer Smart Service Pro App shows live system pressure and temperature data.** (In order to make data available on your smart phone, register the system via Ecoer Smart Service Pro App before charging.)

### [How to end AUTO charge mode]

- Press **BS4 once**
- Automatically exit in 2 hours
- Turn off the system at thermostat

Model	Designed sub-cooling degree (SC)
2Ton	8°F (±2°F)
3Ton	10°F (±2°F)
4Ton-5Ton	8°F (±2°F)

### 3. Charging by weigh-in method

Weigh-in method can be used for the initial installation, or anytime a system charge needs to be replaced. Weigh-in method can also be used when power is not available on job site or ambient temperature is improper to use refrigerant coefficient and sub-cooling charge method.

When use weigh-in method in heating mode, make sure the compressor discharge superheat (DSH) meets the target value. Check it in the app for each AC/HP Details > Diagnosis > Refrigerant Level Judgement in Heating on ESS Pro App.



Query live data by BS3 button to calculate DSH or check SC and DSH via ESS Pro App.

Basically, the liquid line sub-cooling (SC) shall not exceed 30°F in charge mode.

Use **gauge port** connected to compressor suction side to charge the system in heating mode.

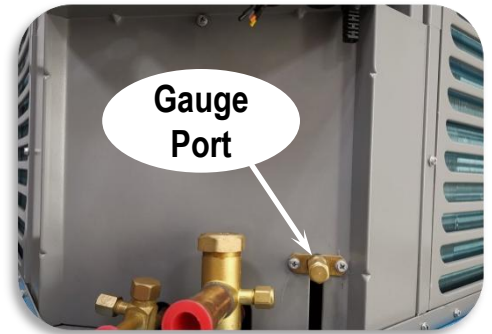

Model	Factory charge	Indoor	Charge amount for ecoer air handler	Charge multiplier for liquid line length <sup>*2</sup>
2436B	The data on nameplate	24K	0	0.6 oz/ft
		36K	0	
4860B		36K	0	
		48K	22oz <sup>*1</sup>	
		60K	22oz <sup>*1</sup>	

- Every condensing unit is factory charged for the smallest rated indoor coil combinations.** An additional amount of refrigerant adjustment is required for a large indoor coil. It's invalid for system with electric heat or other third-party heat source whose capacity is 1.2 times of heat pump nominal capacity.

For example: 3Ton outdoor unit with a 15KW electric heater.  $15 / (3 * 3.516) = 1.42 > 1.2$
- The charging guideline is calculated in 25 ft of standard size line set.** A refrigerant adjustment may be necessary if the line set length is over the per-charged 25 ft (adding 0.6oz/ft on 3/8 liquid line respectively).

# TIPS: How to adjust indoor TXV opening

To keep the best performance and reliability of Ecoer Smart Inverter (ESI) system, be sure liquid line sub-cooling (SC) and compressor suction superheat (SSH) meet our requirements.

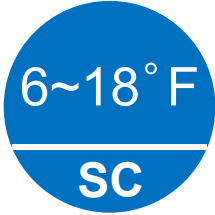

**Target values  
in cooling mode**



•If the LED displays "--" in AUTO charge mode for more than 20 minutes, stop charging and use a wrench to **clockwise** the TXV to ensure  $SSH \geq 7^\circ F$ .

•In case that the cooling performance is abnormal due to improper superheat (i.e.  $SH > 20^\circ F$ ). Proceed as follows to complete the field adjustment.

1. Activate AUTO charge mode from outdoor condensing unit to fix compressor frequency (RPS) by press BS4 for 5 seconds on PCB. **Run the system for 15~20 minutes to check refrigerant coefficient number from LED display or ESS Pro App, add refrigerant until you get 0.6.**
2. Open the front panel of the indoor unit, then use a wrench to **counterclockwise the TXV until  $SH \leq 20^\circ F$** . This will make more refrigerant flow into indoor coil for better cooling performance.

**NOTE: Maintain a minimum operation of 15 minutes** after every refrigerant amount or TXV opening adjustment (the TXV adjustment should be done at  $\frac{1}{4}$  turn each time), then check live SC and SH on Ecoer Smart Service Pro App.

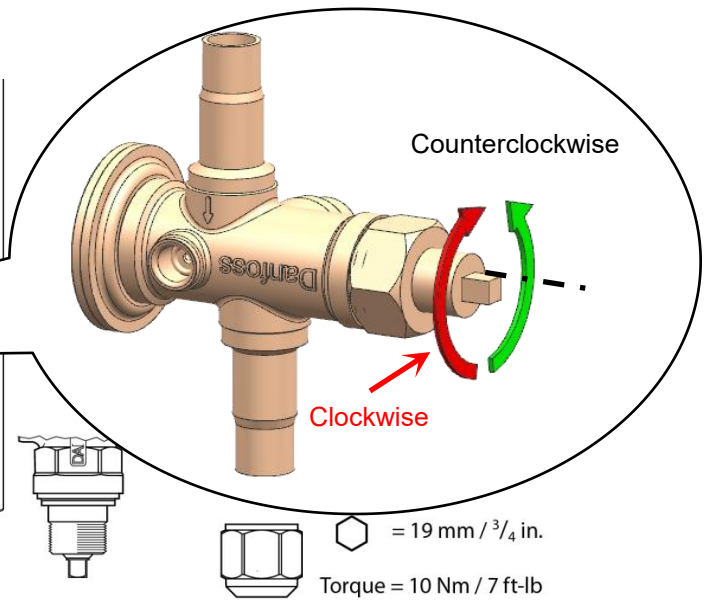
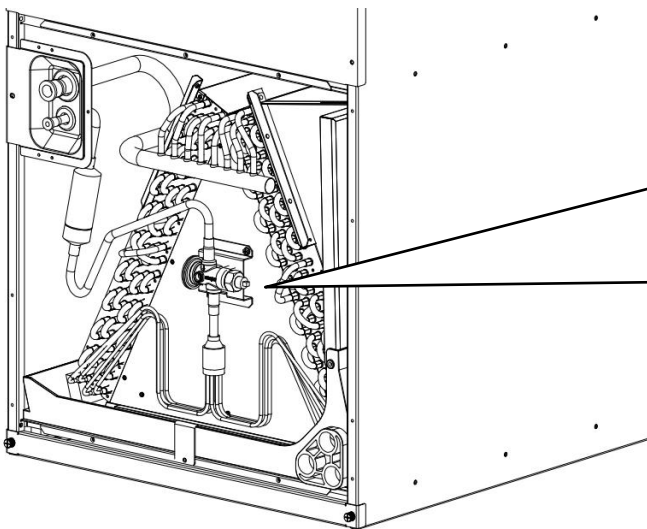

**Remember:**  
Put back the panel after TXV adjusted.

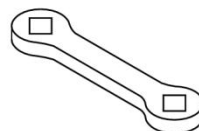

⊕ ⊖  
 $\Delta SH / 1 \text{ turn} / 360^\circ \approx$   
R410A: 0.6°C / 1.1°F

©2023 ECOER INC.

43671 Trade Center Place, Suite 100  
Dulles, VA 20166

Tel: 703-348-2538

[www.ecoer.com](http://www.ecoer.com)